

# ARIPO JOURNAL

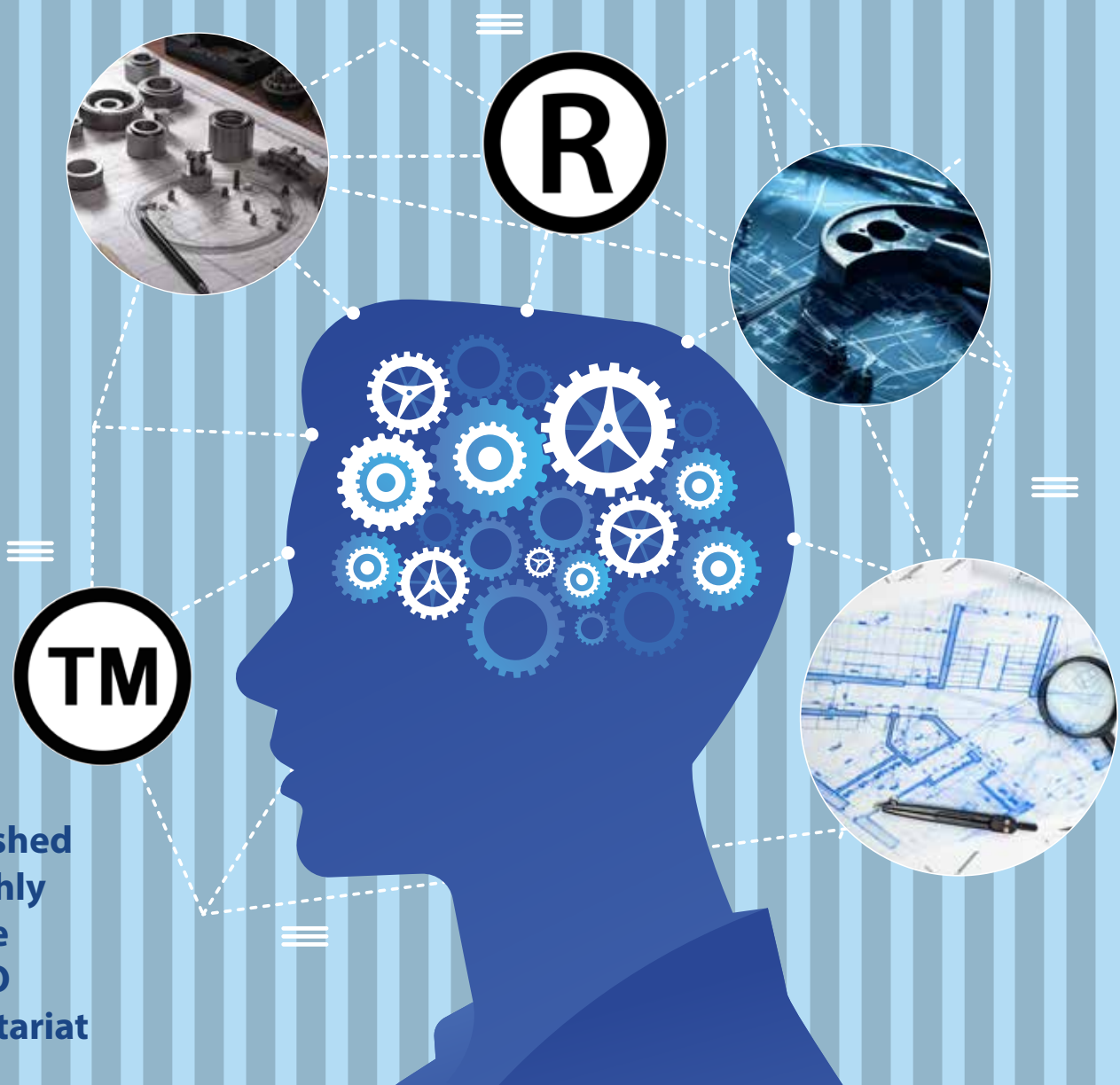

VOL. XLII, No. 7 | 31 July 2025

The Official Industrial Property Journal of ARIPO



Published  
Monthly  
by the  
ARIPO  
Secretariat

## PERMANENT NOTICES

### Lusaka Agreement

The African Regional Intellectual Property Organization (ARIPO) was established by the Lusaka Agreement which was adopted on 9 December, 1976. Objectives of the Organization are, *inter alia*, to promote, harmonize and develop the intellectual property system of the region.

Membership of the Organization is open to states members of the United Nations Economic Commission for Africa or of the African Union. States become members by depositing an instrument of accession to either the Lusaka Agreement or any of the ARIPO Protocols already in force. Currently, Member States of ARIPO are those shown in the table on the right.

### Harare Protocol

The Harare Protocol on Patents and Industrial Designs was adopted on 10 December, 1982. The protocol empowers ARIPO to grant patents and register industrial designs and utility models on behalf of the Harare Protocol contracting states. All ARIPO Member States are signatory to this protocol except Somalia and Mauritius.

### Banjul Protocol

The Banjul Protocol on Marks was adopted on 19 November, 1993. The protocol empowers the Organization to register marks centrally for those ARIPO Member States which are its signatories (see table on this page).

### Swakopmund Protocol

The Swakopmund Protocol on the Protection of Traditional Knowledge and Expressions of Folklore was adopted on 9 August 2010 and entered into force on 11 May 2015. The Protocol introduces a regional framework to protect the traditional knowledge and expressions of folklore of Africa and to ensure that it is properly utilized for the welfare of her people.

### Arusha Protocol

The Arusha Protocol for the Protection of New Varieties of Plants was adopted in Arusha, the United Republic of Tanzania on 6 July 2015.

The protocol entered into force on 24 November 2024. It empowers ARIPO to grant breeders' rights on behalf of the contracting states. This strengthens the agricultural sector by providing farmers with access to improved plant varieties that offer better yields, enhanced disease resistance, and greater adaptability to climate change.

### Patent Cooperation Treaty

The Patent Cooperation Treaty (PCT) is administered by the World Intellectual Property Organization (WIPO). Since the Harare Protocol was linked to the PCT, the PCT has become important to the development of the patent system of all ARIPO Member States.

Accessions / Ratifications					
Member State	Lusaka Agreement	Harare Protocol	Banjul Protocol	Swakopmund Protocol	Arusha Protocol
Botswana	06.02.1985	06.05.1985	29.10.2003	28.03.2012	
Cape Verde	14.07.2022	14.10.2022	14.10.2022	14.10.2022	14.07.2022
eSwatini	17.12.1987	17.03.1988	06.03.1997		
The Gambia	15.02.1978	16.01.1986	03.08.2021	11.02.2015	
Ghana	15.02.1978	25.04.1984			24.11.2023
Kenya	15.02.1978	24.10.1984			
Lesotho	23.07.1987	23.10.1987	12.02.1999		
Liberia	24.12.2009	24.03.2010	24.03.2010	25.10.2016	
Malawi	15.02.1978	25.04.1984	06.03.1997	20.12.2012	
Mauritius	25.09.2020				
Mozambique	08.02.2000	08.05.2000	15.08.2020		
Namibia	14.10.2003	23.04.2004	14.01.2004	11.02.2015	
Rwanda	24.06.2011	24.09.2011		16.07.2012	07.06.2019
São Tomé and Príncipe	19.05.2014	19.08.2014	27.02.2016		29.09.2020
Seychelles	01.10.2021	01.01.2022			
Sierra Leone	05.12.1980	25.02.1999			
Somalia	10.12.1981				
Sudan	02.05.1978	25.04.1984			
Tanzania	12.10.1983	01.09.1999	01.09.1999		
Uganda	08.08.1978	25.04.1984	21.11.2000		
Zambia	15.02.1978	26.02.1986		28.08.2015	
Zimbabwe	11.11.1980	25.04.1984	06.03.1997	22.04.2013	

## EDITORIAL

### Frequency of the Journal

The ARIPO Journal: the Official Industrial Property Journal of ARIPO is published every month.

### Editorial Office and Mission

The Journal is published by the ARIPO Office as part of the industrial property process under the Harare Protocol and the Banjul Protocol. (For address of the ARIPO Office, please see the section on 'Purchases and Subscriptions' and 'General Contact Addresses' below.)

### Advertisements

Any person, natural or body corporate, may advertise in the Journal on a matter of, or relating to, intellectual property (such as vacancies, new appointments, meetings, etc.). The cost of advertisement is:

- a) US \$20.00 per half column, or part thereof, measuring size 8.5 cm (across) X 12 cm (depth);
- b) US \$35.00 per full column, or part thereof, measuring size 8.5 cm (across) X 24 cm (depth);
- c) US \$40.00 per half page and US \$70.00 per full page.

Concessionary rates are available at 20% reduced rate for any number of multiple insertions.

### Purchases and Subscriptions

The ARIPO Journal is available on the ARIPO e-service platform (<http://eservice.aripo.org/ppb/pjd/PPBJournalViewList.do>) for free downloading.

However, should any reader prefer the print format over the electronic version, purchases can be made at US\$ 100.00 per paper copy. Annual subscriptions (inclusive of postage) are at US \$1 200.00. All purchases and subscriptions can be made at the following address:

**Physical:**

ARIPO Office, No. 11 Natal Road, Belgravia, Harare, Zimbabwe.

**Postal:**

Director General, ARIPO, P.O. Box 4228, Harare, Zimbabwe.

### General Contact Addresses

Communication with, or information about, the Organization for any matter generally may be made or obtained at the following addresses in addition to the ones indicated above:

**Telephone:**

+263 (242) 794065/6/8, 794074.

**VOIP:**

+263 8677005131/32.

**E-mail:**

<mail@aripo.org>.

**Website:**

<www.aripo.org>.

## CONTENTS

<b>Permanent Notices</b>		<b>2</b>
Lusaka Agreement	2	
Harare Protocol	2	
Banjul Protocol	2	
Swakopmund Protocol	2	
Arusha Protocol	2	
Patent Cooperation Treaty	2	
Accessions / Ratifications	2	
<b>Editorial</b>		<b>3</b>
Frequency of the Journal	3	
Editorial Office and Mission	3	
Advertisements	3	
Purchases and Subscriptions	3	
General Contact Addresses	3	
<b>General Notices</b>		<b>4</b>
Data Flow Symbols	4	
Data Identification Codes	4	
INID Codes For Marks	4	
INID Codes For Patents	4	
INID Codes For Industrial Designs	5	
Country / Organization Codes		
used in this Issue of the Journal	5	
<b>Marks</b>		<b>6</b>
Mark Applications Filed	6	
Mark Applications Assigned	14	
Marks Pending Registration	16	
Marks Registered	21	
Marks Renewed	27	
<b>Patents</b>		<b>28</b>
Patent Applications Filed	28	
Erratum: Patent Applications Filed	35	
Patent Applications Renewed	36	
Patent Applications Lapsed/Abandoned	46	
Patents and Patent Applications Restored	48	
Patent Applications Pending Grant	49	
Patents Granted	54	
Classification Index of Granted		
Patents	75	
Patentees' Name Index of Granted		
Patents	77	
ARIPO Application Number Index		
of Granted Patents	79	
Patents Renewed	81	
<b>Utility Models</b>		<b>88</b>
Utility Model Applications Filed	88	
Utility Model Applications Abandoned	88	
Utility Model Applications Pending		
Registration	88	
Utility Model Applications Renewed	89	
Utility Models Registered	90	
Utility Models Renewed	91	
<b>Designs</b>		<b>92</b>
Design Applications Filed	92	
Design Applications Lapsed	92	
Design Applications Renewed	93	
Designs Registered	94	
Designs Renewed	123	
<b>Search Requests</b>		<b>125</b>
Search Requests Filed	125	

# GENERAL NOTICES

## Data Flow Symbols

Symbols in the following table are ARIPO-originated and are used in this publication for directing the flow of announcement columns, namely that a record (which is the largest unit in an announcement column) is ended and that an announcement column continues on the next page or it is ended.

Symbol	Interpretation	Symbol	Interpretation
● ●	End of a record in an announcement column	▶	An announcement column continues on the next page
■	End of an announcement column		

## Data Identification Codes

The data identification codes appearing in the next four tables are WIPO Standards. The first three of these tables contain codes universally known as Internationally recognized Numbers for the Identification of Data (INID) Codes. These Standards are, namely, WIPO Standard ST. 60 (Recommendation concerning bibliographic data relating to marks), Standard ST. 9 (Recommendation concerning bibliographic data on and relating to patents and supplementary protection certificates (SPCs)), Standard ST. 80 (Recommendation concerning bibliographic data relating to industrial designs) and Standard ST. 3 (Recommended standard on two-letter codes for the representation of states, other entities and intergovernmental organizations).

### INID Codes For Marks

Code	Interpretation	Code	Interpretation	Code	Interpretation
(111)	Registration number	(511)	Symbol of the Nice Class	(740)	Representative's name
(151)	Date of registration	(540)	Description of the mark	(814)	Designated states
(210)	Application number	(580)	Date of recorded change	(869)	Accepted with reserve
(220)	Filing date	(731)	Applicant's name		

### INID Codes For Patents

Code	Interpretation	Code	Interpretation	Code	Interpretation
(11)	Patent number	(54)	Title of the invention	(73)	Name(s) of holder(s) of patent or patentee's name. If in announcements concerning " <i>Patent Applications Assigned</i> " or " <i>Patents Assigned</i> ", this code represents the name of the assignor (or the name of the current owner of the patent application or the name of the current owner of the patent)
(21)	Application number	(56)	List of prior art documents cited in the examination	(74)	Attorney's name
(22)	Filing date	(57)	Abstract	(75)	Name(s) of inventor(s) who is/are also applicant(s)
(23)	Date when action is to be taken, if in announcements for " <i>Patent Applications Pending Grant</i> "; date from which status takes effect, if in " <i>Applications Abandoned</i> " or in " <i>Patents Abandoned</i> "	(71)	Applicant's name. If in announcements concerning " <i>Patent Applications Assigned</i> " or " <i>Patents Assigned</i> ", this code represents the name of the assignee (or the name of the new owner of the patent application or the name of the new owner of the patent)	(84)	States designated under the Harare Protocol
(24)	Effective date of patent	(72)	Name(s) of inventor(s)	(86)	Patent Cooperation Treaty (PCT) international filing date and number
(31)	Priority number			(96)	Harare Protocol filing date and number
(32)	Priority date				
(33)	Convention country / Convention organization				
(45)	Date of publication				
(51)	Symbol of the International Patent Classification (IPC)				

## Data Identification Codes (Contd.)

### INID Codes For Industrial Designs

Code	Interpretation	Code	Interpretation	Code	Interpretation
(11)	Design registration number	(40)	Publication date	(74)	Attorney's name
(21)	Design application number	(51)	Symbol of the Locarno Classification	(75)	Name(s) of creator(s) who is/are also applicant(s)
(22)	Filing date	(54)	Title of the design	(84)	States designated under the Harare Protocol
(24)	Effective date of registration of design	(55)	Symbol of the design		
(31)	Priority number	(71)	Applicant's name		
(32)	Priority date	(72)	Name of creator of the design		
(33)	Convention country / Convention organization	(73)	Name of holder of the design registration		

### Country/Organization Codes Used in this Issue of the Journal

Code	Country / Organization	Code	Country / Organization	Code	Country / Organization
AP	African Regional Intellectual Property Organization (ARIPO)	KE	Kenya	WO	World Intellectual Property Organization (WIPO) (International Bureau of)
AU	Australia	KR	Republic of Korea	ZA	South Africa
BR	Brazil	LR	Liberia	ZM	Zambia
BW	Botswana	LS	Lesotho	ZW	Zimbabwe
CN	China	MW	Malawi		
CV	Cape Verde	MZ	Mozambique		
DE	Germany	NA	Namibia		
EP	European Patent Office	RU	Russian Federation		
ES	Spain	RW	Rwanda		
FI	Finland	SC	Seychelles		
FR	France	SD	Sudan		
GB	Great Britain	SL	Sierra Leone		
GH	Ghana	ST	São Tomé and Príncipe		
GM	The Gambia	SZ	eSwatini		
IN	India	TZ	United Republic of Tanzania		
IT	Italy	UG	Uganda		
JP	Japan	US	United States of America		

# MARKS

## Mark Applications Filed

(210) AP/M/2025/007427  
 (220) 02.07.2025  
 (511) Int. Cl. 3: BW, CV, GM, LR, LS, MW, MZ, NA, ST, SZ, TZ, UG, ZW  
 (731) AR ATTARWALA LLP  
 (740) Cronjé & Co.  
 (814) BW, CV, GM, LR, LS, MW, MZ, NA, ST, SZ, TZ, UG, ZW



(210) AP/M/2025/007428  
 (220) 02.07.2025  
 (511) Int. Cl. 7: BW, CV, GM, LR, LS, MW, MZ, NA, ST, SZ, TZ, UG, ZW  
 (731) RADWAN GENERAL TRADING (LLC)  
 (740) Cronjé & Co.  
 (814) BW, CV, GM, LR, LS, MW, MZ, NA, ST, SZ, TZ, UG, ZW



(210) AP/M/2025/007429  
 (220) 02.07.2025  
 (511) Int. Cl. 2, 16, 35 and 37: ZW  
 (731) CARTRIX PRIME (PRIVATE) LIMITED  
 (740) HONEY & BLANCKENBERG  
 (814) ZW



(210) AP/M/2025/007430  
 (220) 04.07.2025  
 (511) Int. Cl. 12: BW, CV, GM, LR, LS, MW, MZ, NA, ST, SZ, TZ, UG, ZW  
 (731) ELECTRA GENERAL TRADING FZE  
 (740) Cronjé & Co.  
 (814) BW, CV, GM, LR, LS, MW, MZ, NA, ST, SZ, TZ, UG, ZW



(210) AP/M/2025/007431  
 (220) 07.07.2025  
 (511) Int. Cl. 5: BW, CV, GM, LR, LS, MW, MZ, NA, SZ, TZ, UG, ZW  
 (731) PATRICKLINGO PHARMACEUTICALS LIMITED  
 (740) Becky and Tsilo Agency Private Business Corporation  
 (814) BW, CV, GM, LR, LS, MW, MZ, NA, SZ, TZ, UG, ZW



(210) AP/M/2025/007432  
 (220) 07.07.2025  
 (511) Int. Cl. 5: BW, CV, GM, LR, LS, MW, MZ, NA, SZ, TZ, UG, ZW  
 (731) PATRICKLINGO PHARMACEUTICALS LIMITED  
 (740) Becky and Tsilo Agency Private Business Corporation  
 (814) BW, CV, GM, LR, LS, MW, MZ, NA, SZ, TZ, UG, ZW



(210) AP/M/2025/007433  
 (220) 07.07.2025  
 (511) Int. Cl. 14, 18 and 25: ZW  
 (731) MAMVURA Farai Mutema  
 (740) Mutema Mamvura Farai  
 (814) ZW



*Tsumo Heritage*

(210) AP/M/2025/007434  
 (220) 08.07.2025  
 (511) Int. Cl. 9, 39, 42 and 43: BW, MW, MZ, NA, SZ, TZ, UG, ZW  
 (731) INNISCOR INTERNATIONAL FRANCHISING LIMITED

(740) HONEY & BLANCKENBERG  
 (814) BW, MW, MZ, NA, SZ, TZ, UG, ZW



(210) AP/M/2025/007435  
 (220) 08.07.2025  
 (511) Int. Cl. 34: BW, CV, GM, LR, LS, MW, MZ, NA, ST, SZ, TZ, UG, ZW  
 (731) HONGKONG VANLIEW TECHNOLOGY CO., LIMITED  
 (740) NGWENYA Mthokozisi  
 (814) BW, CV, GM, LR, LS, MW, MZ, NA, ST, SZ, TZ, UG, ZW

(540) ALIBARBAR

(210) AP/M/2025/007436  
 (220) 08.07.2025  
 (511) Int. Cl. 34: BW, CV, GM, LR, LS, MW, MZ, NA, ST, SZ, TZ, UG, ZW  
 (731) HONGKONG VANLIEW TECHNOLOGY CO., LIMITED  
 (740) NGWENYA Mthokozisi  
 (814) BW, CV, GM, LR, LS, MW, MZ, NA, ST, SZ, TZ, UG, ZW



## Mark Applications Filed (Contd.)

(210) AP/M/2025/007437  
(220) 08.07.2025  
(511) Int. Cl. 3: BW, CV, GM, LR, LS, MW, MZ, NA, ST, SZ, TZ, UG, ZW  
(731) BAKHRESA HOLDINGS LTD  
(740) CRB AFRICA LEGAL  
(814) BW, CV, GM, LR, LS, MW, MZ, NA, ST, SZ, TZ, UG, ZW

(540)



••

(210) AP/M/2025/007438  
(220) 08.07.2025  
(511) Int. Cl. 34: BW, CV, GM, LR, LS, MW, MZ, NA, ST, SZ, TZ, UG, ZW  
(731) HONGKONG VANLIEW TECHNOLOGY CO., LIMITED  
(740) NGWENYA Mthokozisi  
(814) BW, CV, GM, LR, LS, MW, MZ, NA, ST, SZ, TZ, UG, ZW

(540)



••

(210) AP/M/2025/007439  
(220) 08.07.2025  
(511) Int. Cl. 29: BW, CV, GM, LR, LS, MW, MZ, NA, ST, SZ, TZ, UG, ZW  
(731) BAKHRESA HOLDINGS LTD  
(740) CRB AFRICA LEGAL  
(814) BW, CV, GM, LR, LS, MW, MZ, NA, ST, SZ, TZ, UG, ZW

(540)



••

(210) AP/M/2025/007440  
(220) 08.07.2025  
(511) Int. Cl. 18 and 25: TZ, UG  
(731) GUANGZHOU AMITIN TRADING COMPANY LTD.  
(740) D'ALMEIDA NIDIA  
(814) TZ, UG

(540)



••

(210) AP/M/2025/007441  
(220) 08.07.2025  
(511) Int. Cl. 9: BW, MW, MZ, NA, ST, ZW  
(731) HELLERMANNTYTON (PTY) LIMITED  
(740) SAMURIWO ATTORNEYS  
(814) BW, MW, MZ, NA, ST, ZW

(540) **HELAGLAND**

••

(210) AP/M/2025/007442  
(220) 08.07.2025  
(511) Int. Cl. 35: ZW  
(731) DE REFLEXION CONSULTING (PRIVATE) LIMITED  
(740) DE REFLEXION CONSULTING (PRIVATE) LIMITED  
(814) ZW

(540)



••

(210) AP/M/2025/007443  
(220) 09.07.2025  
(511) Int. Cl. 36: ZW  
(731) FIDELITY LIFE ASSURANCE OF ZIMBABWE LIMITED  
(740) MARUFU Tsungirirai  
(814) ZW

(540)



**FIDELITY LIFE**  
ASSURANCE OF ZIMBABWE

VAKAI DZENYU

••

(210) AP/M/2025/007444  
(220) 09.07.2025  
(511) Int. Cl. 36: ZW  
(731) FIDELITY LIFE ASSURANCE OF ZIMBABWE LIMITED  
(740) MARUFU Tsungirirai  
(814) ZW

(540)



**FIDELITY LIFE**  
ASSURANCE OF ZIMBABWE

YAKHANI EZENYU

••

(210) AP/M/2025/007445  
(220) 09.07.2025  
(511) Int. Cl. 32: TZ, UG  
(731) SIERRA PREMIUM BREWERIES LIMITED  
(740) Cronjé & Co.  
(814) TZ, UG

(540) **CHECHE**

••

(210) AP/M/2025/007446  
(220) 09.07.2025  
(511) Int. Cl. 7 and 9: NA  
(731) SHENZHEN BAANOOL ROBOT CO., LTD  
(740) NGWENYA Mthokozisi  
(814) NA

(540) **BAANOOL**

••

(210) AP/M/2025/007447  
(220) 09.07.2025  
(511) Int. Cl. 5: BW, GM, LR, MW, MZ, NA, TZ, UG, ZW  
(731) BLISS GVS PHARMA LTD  
(740) KITAKA MARTIN  
(814) BW, GM, LR, MW, MZ, NA, TZ, UG, ZW

(540) **SANFIXIME**

••

(210) AP/M/2025/007448  
(220) 09.07.2025  
(511) Int. Cl. 5: BW, GM, LR, MW, MZ, NA, TZ, UG, ZW  
(731) BLISS GVS PHARMA LTD  
(740) KITAKA MARTIN  
(814) BW, GM, LR, MW, MZ, NA, TZ, UG, ZW

(540) **SANFUROX**

••

(210) AP/M/2025/007449  
(220) 09.07.2025  
(511) Int. Cl. 5: BW, GM, LR, MW, MZ, NA, TZ, UG, ZW  
(731) BLISS GVS PHARMA LTD  
(740) KITAKA MARTIN  
(814) BW, GM, LR, MW, MZ, NA, TZ, UG, ZW

(540) **SURDEX**

••



## Mark Applications Filed (Contd.)

(210) AP/M/2025/007450  
(220) 09.07.2025  
(511) Int. Cl. 5: BW, GM, LR, MW, MZ, NA, TZ, UG, ZW  
(731) BLISS GVS PHARMA LTD  
(740) KITAKA MARTIN  
(814) BW, GM, LR, MW, MZ, NA, TZ, UG, ZW

(540) **TRAXALOT**



(210) AP/M/2025/007451  
(220) 09.07.2025  
(511) Int. Cl. 5: BW, GM, LR, MW, MZ, NA, TZ, UG, ZW  
(731) BLISS GVS PHARMA LTD  
(740) KITAKA MARTIN  
(814) BW, GM, LR, MW, MZ, NA, TZ, UG, ZW

(540) **TYRIDOL-P**



(210) AP/M/2025/007452  
(220) 10.07.2025  
(511) Int. Cl. 11 and 37: ZW  
(731) PROAIR  
(740) Proverbs investments T/A ProAir Air Conditioning  
(814) ZW  
(540)



(210) AP/M/2025/007453  
(220) 10.07.2025  
(511) Int. Cl. 9: BW, CV, GM, LR, LS, MW, MZ, NA, ST, SZ, TZ, UG, ZW  
(731) WE.YAN LIMITED  
(740) INVENTA MOZAMBIQUE, LDA.  
(814) BW, CV, GM, LR, LS, MW, MZ, NA, ST, SZ, TZ, UG, ZW

(540) **we.yan**



(210) AP/M/2025/007454  
(220) 11.07.2025  
(511) Int. Cl. 34: BW, CV, GM, LR, LS, MW, MZ, NA, ST, SZ, TZ, UG, ZW  
(731) KHAIRAT AL MINAFIE CO FOR TRANSPORT AND GENERAL TRADING FOOD  
(740) B. W. KAHARI LEGAL PRACTITIONERS

(814) BW, CV, GM, LR, LS, MW, MZ, NA, ST, SZ, TZ, UG, ZW

(540)



(210) AP/M/2025/007455  
(220) 11.07.2025  
(511) Int. Cl. 34: BW, CV, GM, LR, LS, MW, MZ, NA, ST, SZ, TZ, UG, ZW  
(731) KHAIRAT AL MINAFIE CO FOR TRANSPORT AND GENERAL TRADING FOOD  
(740) B. W. KAHARI LEGAL PRACTITIONERS  
(814) BW, CV, GM, LR, LS, MW, MZ, NA, ST, SZ, TZ, UG, ZW

(540)



(210) AP/M/2025/007456  
(220) 11.07.2025  
(511) Int. Cl. 34: BW, CV, GM, LR, LS, MW, MZ, NA, ST, SZ, TZ, UG, ZW  
(731) BLVK AFRICA (PTY) LTD  
(740) Cronjé & Co.  
(814) BW, CV, GM, LR, LS, MW, MZ, NA, ST, SZ, TZ, UG, ZW

(540) **BLVK**



(210) AP/M/2025/007457  
(220) 11.07.2025  
(511) Int. Cl. 41 and 42: BW, CV, GM, LR, LS, MW, MZ, NA, ST, SZ, TZ, UG, ZW  
(731) GURUFLOW TEAM LTD  
(740) PALLADIUM STRATEGY & IP CONSULTANTS  
(814) BW, CV, GM, LR, LS, MW, MZ, NA, ST, SZ, TZ, UG, ZW

(540) **PIN-UP**



(210) AP/M/2025/007458  
(220) 14.07.2025  
(511) Int. Cl. 5: BW, GM, LR, MW, MZ, NA, TZ, UG, ZW  
(731) BLISS GVS PHARMA LTD  
(740) KITAKA MARTIN  
(814) BW, GM, LR, MW, MZ, NA, TZ, UG, ZW

(540) **TRIMIC**



(210) AP/M/2025/007459  
(220) 14.07.2025  
(511) Int. Cl. 5: BW, GM, LR, MW, MZ, NA, TZ, UG, ZW  
(731) BLISS GVS PHARMA LTD  
(740) KITAKA MARTIN  
(814) BW, GM, LR, MW, MZ, NA, TZ, UG, ZW

(540) **VAGID**



(210) AP/M/2025/007460  
(220) 14.07.2025  
(511) Int. Cl. 5: BW, GM, LR, MW, MZ, NA, TZ, UG, ZW  
(731) BLISS GVS PHARMA LTD  
(740) KITAKA MARTIN  
(814) BW, GM, LR, MW, MZ, NA, TZ, UG, ZW

(540) **VUZTAN**



(210) AP/M/2025/007461  
(220) 14.07.2025  
(511) Int. Cl. 5: BW, GM, LR, MW, MZ, NA, TZ, UG, ZW  
(731) BLISS GVS PHARMA LTD  
(740) KITAKA MARTIN  
(814) BW, GM, LR, MW, MZ, NA, TZ, UG, ZW

(540) **XIGPA**



(210) AP/M/2025/007462  
(220) 14.07.2025  
(511) Int. Cl. 5: BW, GM, LR, MW, MZ, NA, TZ, UG, ZW  
(731) BLISS GVS PHARMA LTD  
(740) KITAKA MARTIN  
(814) BW, GM, LR, MW, MZ, NA, TZ, UG, ZW

(540) **ZUSIT**



(210) AP/M/2025/007463  
(220) 14.07.2025  
(511) Int. Cl. 5: BW, GM, LR, MW, MZ, NA, TZ, UG, ZW  
(731) BLISS GVS PHARMA LTD  
(740) KITAKA MARTIN  
(814) BW, GM, LR, MW, MZ, NA, TZ, UG, ZW

(540) **XIPRO**



## Mark Applications Filed (Contd.)

(210) AP/M/2025/007464  
(220) 15.07.2025  
(511) Int. Cl. 32: ZW  
(731) NHANDARO GROUP PVT LTD  
(740) NGOSHI Glen  
(814) ZW



(210) AP/M/2025/007465  
(220) 16.07.2025  
(511) Int. Cl. 36: ZW  
(731) FIDELITY LIFE ASSURANCE OF ZIMBABWE LIMITED  
(740) MARUFU Tsungirirai  
(814) ZW

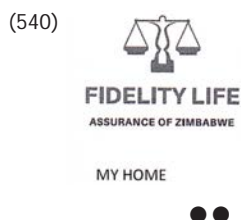

(210) AP/M/2025/007466  
(220) 16.07.2025  
(511) Int. Cl. 36: ZW  
(731) FIDELITY LIFE ASSURANCE OF ZIMBABWE LIMITED  
(740) MARUFU Tsungirirai  
(814) ZW

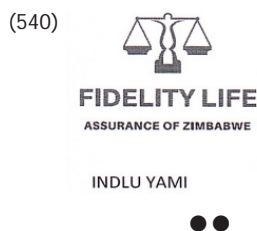

(210) AP/M/2025/007467  
(220) 16.07.2025  
(511) Int. Cl. 36: ZW  
(731) FIDELITY LIFE ASSURANCE OF ZIMBABWE LIMITED  
(740) MARUFU Tsungirirai  
(814) ZW

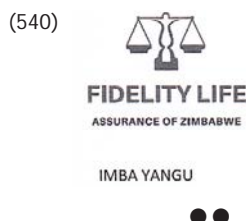

(210) AP/M/2025/007468  
(220) 16.07.2025  
(511) Int. Cl. 39: BW, CV, GM, LR, LS, MW, MZ, NA, ST, SZ, TZ, UG, ZW  
(731) INTERNATIONAL MOBILITY GROUP LIMITED  
(740) INVENTA MOZAMBIQUE, LDA.  
(814) BW, CV, GM, LR, LS, MW, MZ, NA, ST, SZ, TZ, UG, ZW



(210) AP/M/2025/007469  
(220) 16.07.2025  
(511) Int. Cl. 7 and 8: BW, CV, GM, LR, LS, MW, MZ, NA, ST, SZ, TZ, UG, ZW  
(731) GAD s INTERNACIONAL COMPANY S.A  
(740) HUSSEIN & Co.  
(814) BW, CV, GM, LR, LS, MW, MZ, NA, ST, SZ, TZ, UG, ZW



(210) AP/M/2025/007470  
(220) 16.07.2025  
(511) Int. Cl. 9: BW, CV, GM, LR, LS, MW, MZ, NA, ST, SZ, TZ, UG, ZW  
(731) HIKMA AL NUR TRADING LLC  
(740) Cronjé & Co.  
(814) BW, CV, GM, LR, LS, MW, MZ, NA, ST, SZ, TZ, UG, ZW



(210) AP/M/2025/007471  
(220) 17.07.2025  
(511) Int. Cl. 43: BW, LS, MZ, NA, SZ, ZW  
(731) YOGURTLAND FRANCHISING, INC  
(740) UNITED TRADEMARK & PATENT SERVICES LIMITED  
(814) BW, LS, MZ, NA, SZ, ZW



(210) AP/M/2025/007472  
(220) 17.07.2025  
(511) Int. Cl. 36: ZW  
(731) HARBORVIEW ESTATES (PRIVATE) LIMITED  
(740) HONEY & BLANCKENBERG  
(814) ZW



(210) AP/M/2025/007473  
(220) 17.07.2025  
(511) Int. Cl. 1: BW, CV, GM, LR, LS, MW, MZ, NA, ST, SZ, TZ, UG, ZW  
(731) FERTOP AGREICULTURE (PRIVATE) LIMITED  
(740) MAWERE AND SIBANDA LEGAL PRACTITIONERS  
(814) BW, CV, GM, LR, LS, MW, MZ, NA, ST, SZ, TZ, UG, ZW



(210) AP/M/2025/007474  
(220) 17.07.2025  
(511) Int. Cl. 3: BW, CV, GM, LR, LS, MW, MZ, NA, ST, SZ, TZ, UG, ZW  
(731) UKANI Maulesh D  
(740) B. W. KAHARI LEGAL PRACTITIONERS  
(814) BW, CV, GM, LR, LS, MW, MZ, NA, ST, SZ, TZ, UG, ZW



(210) AP/M/2025/007475  
(220) 17.07.2025  
(511) Int. Cl. 5, 9 and 10: BW, CV, GM, LR, LS, MW, MZ, NA, ST, SZ, TZ, UG, ZW  
(731) ROCHE DIAGNOSTICS GMBH  
(740) FISHER CORMACK & BOTHA  
(814) BW, CV, GM, LR, LS, MW, MZ, NA, ST, SZ, TZ, UG, ZW



## Mark Applications Filed (Contd.)

(210) AP/M/2025/007476  
(220) 17.07.2025  
(511) Int. Cl. 36: ZW  
(731) HARBORVIEW ESTATES (PRIVATE) LIMITED  
(740) HONEY & BLANCKENBERG  
(814) ZW  
(540)



••

(210) AP/M/2025/007477  
(220) 18.07.2025  
(511) Int. Cl. 32 and 33: ZW  
(731) NYANGANI INDUSTRIES (PVT) LTD  
(740) REDDY Jalla Karunakara  
(814) ZW

(540) **KINGSSMAN**

••

(210) AP/M/2025/007478  
(220) 18.07.2025  
(511) Int. Cl. 32 and 33: ZW  
(731) NYANGANI INDUSTRIES (PVT) LTD  
(740) REDDY Jalla Karunakara  
(814) ZW

(540) **LARDS**

••

(210) AP/M/2025/007479  
(220) 18.07.2025  
(511) Int. Cl. 35 and 41: ZW  
(731) BUYZWC PRIVATE LIMITED  
(740) SOLOMONI Tendai Shadreck  
(814) ZW

(540)



••

(210) AP/M/2025/007480  
(220) 18.07.2025  
(511) Int. Cl. 35 and 42: ZW  
(731) BUYZWC PRIVATE LIMITED

(740) SOLOMONI Tendai Shadreck  
(814) ZW

(540)



••

(210) AP/M/2025/007481  
(220) 18.07.2025  
(511) Int. Cl. 1 and 7: ZW  
(731) MOREHARVEST INVESTMENTS (PRIVATE) LIMITED

(740) Ranchhod Associates  
(814) ZW

(540)



••

(210) AP/M/2025/007482  
(220) 21.07.2025  
(511) Int. Cl. 30: ZW  
(731) MILLERS MART PRIVATE LIMITED  
(740) CHIGAGA Apphia  
(814) ZW

(540)



••

(210) AP/M/2025/007483  
(220) 21.07.2025  
(511) Int. Cl. 16 and 32: MZ, ZW  
(731) RUSIKE Nathan  
(740) RUSIKE Nathan  
(814) MZ, ZW

(540)



••

(210) AP/M/2025/007484  
(220) 21.07.2025  
(511) Int. Cl. 16 and 32: MZ, ZW  
(731) RUSIKE Nathan  
(740) RUSIKE Nathan  
(814) MZ, ZW

(540)



••

(210) AP/M/2025/007485  
(220) 21.07.2025  
(511) Int. Cl. 9, 11, 35, 37 and 42: BW, CV, GM, LR, LS, MW, MZ, NA, ST, SZ, TZ, UG, ZW

(731) E.W. INFORMATION SYSTEMS LIMITED

(740) HONEY & BLANCKENBERG  
(814) BW, CV, GM, LR, LS, MW, MZ, NA, ST, SZ, TZ, UG, ZW

(540)



••

(210) AP/M/2025/007486  
(220) 21.07.2025  
(511) Int. Cl. 9, 11, 35, 37 and 42: BW, CV, GM, LR, LS, MW, MZ, NA, ST, SZ, TZ, UG, ZW

(731) E.W. INFORMATION SYSTEMS LIMITED

(740) HONEY & BLANCKENBERG  
(814) BW, CV, GM, LR, LS, MW, MZ, NA, ST, SZ, TZ, UG, ZW

(540)



••

(210) AP/M/2025/007487  
(220) 22.07.2025  
(511) Int. Cl. 30: ZW  
(731) MILLERS MART PRIVATE LIMITED  
(740) CHIGAGA Apphia  
(814) ZW

(540)



••

## Mark Applications Filed (Contd.)

(210) AP/M/2025/007488  
(220) 22.07.2025  
(511) Int. Cl. 30: ZW  
(731) MILLERS MART PRIVATE LIMITED  
(740) CHIGAGA Apphia  
(814) ZW

(540)



(210) AP/M/2025/007489  
(220) 22.07.2025  
(511) Int. Cl. 9, 35, 36, 38, 41, 42 and 45:  
BW, MW, MZ, NA, ZW

(731) MTN GROUP MANAGEMENT  
SERVICES (PROPRIETARY) LIMITED  
(740) ENSafrica Namibia  
(814) BW, MW, MZ, NA, ZW

(540) **MTN ONE**



(210) AP/M/2025/007490  
(220) 22.07.2025  
(511) Int. Cl. 37: ZW  
(731) HENGJI INVESTMENTS  
(740) SCANLEN & HOLDERNESS  
(814) ZW

(540)



(210) AP/M/2025/007491  
(220) 23.07.2025  
(511) Int. Cl. 9 and 42: BW, LR, MW, MZ,  
NA, ST, ZW

(731) CISCO TECHNOLOGY, INC.  
(740) ROLAND INTELLECTUAL PROPERTY  
CONSULTANTS  
(814) BW, LR, MW, MZ, NA, ST, ZW

(540) **CISCO**



(210) AP/M/2025/007492  
(220) 23.07.2025  
(511) Int. Cl. 9 and 42: BW, LR, MW, MZ,  
NA, ST, ZW

(731) CISCO TECHNOLOGY, INC.

(740) ROLAND INTELLECTUAL PROPERTY  
CONSULTANTS

(814) BW, LR, MW, MZ, NA, ST, ZW

(540)



(210) AP/M/2025/007493  
(220) 24.07.2025  
(511) Int. Cl. 41: ZW  
(731) ANGLICAN DIOCESE OF HARARE  
(740) ANGLICAN DIOCESE OF HARARE  
(814) ZW

(540)



(210) AP/M/2025/007494  
(220) 24.07.2025  
(511) Int. Cl. 9, 35, 38, 41 and 42: BW,  
MW, MZ, NA, ZW

(731) SOUTH AFRICAN AIRWAYS SOC  
LIMITED

(740) ENSafrica Namibia  
(814) BW, MW, MZ, NA, ZW

(540) **AIRSCAPE**



(210) AP/M/2025/007495  
(220) 24.07.2025  
(511) Int. Cl. 42: ZW  
(731) JULY TWENTY EIGHT (PRIVATE)  
LIMITED  
(740) July Twenty Eight (Private) Limited  
(814) ZW

(540)



(210) AP/M/2025/007496  
(220) 25.07.2025  
(511) Int. Cl. 9: BW, CV, GM, LR, LS, MW,  
MZ, NA, ST, SZ, TZ, UG, ZW

(731) GUANGZHOU KELLY ELECTRONIC  
TECHNOLOGY CO., LTD.

(740) Cronjé & Co.  
(814) BW, CV, GM, LR, LS, MW, MZ, NA,  
ST, SZ, TZ, UG, ZW

(540) **KLYSTAR**



(210) AP/M/2025/007497  
(220) 25.07.2025  
(511) Int. Cl. 9: BW, CV, GM, LR, LS, MW,  
MZ, NA, ST, SZ, UG, ZW

(731) GUANGZHOU KELLY ELECTRONIC  
TECHNOLOGY CO., LTD.

(740) Cronjé & Co.  
(814) BW, CV, GM, LR, LS, MW, MZ, NA,  
ST, SZ, UG, ZW

(540) **KLY**



(210) AP/M/2025/007498  
(220) 28.07.2025  
(511) Int. Cl. 32 and 33: ZW  
(731) NHANDARO GROUP PVT LTD  
(740) NGOSHI Glen  
(814) ZW

(540)



(210) AP/M/2025/007499  
(220) 28.07.2025  
(511) Int. Cl. 7: ZW  
(731) A.LUCKY BRAND (PVT) LTD  
(740) HUSSEIN & Co.  
(814) ZW

(540) **GOAL POWER**



(210) AP/M/2025/007500  
(220) 06.08.2025  
(511) Int. Cl. 1, 2, 3, 4, 5, 6, 7, 8, 9, 10,  
11, 12, 13, 14, 15, 16, 17, 18, 19,  
20, 21, 22, 23, 24, 25, 26, 27, 28,  
29, 30, 31, 32, 33, 34, 35, 36, 37,  
38, 39, 40, 41, 42, 43, 44 and 45:  
BW, CV, GM, LR, LS, MW, MZ, NA,  
ST, SZ, TZ, UG, ZW

(731) TANZANIA TRADE DEVELOPMENT  
AUTHORITY

(740) MSAGA JOHN LEAH  
(814) BW, CV, GM, LR, LS, MW, MZ, NA,  
ST, SZ, TZ, UG, ZW

(540)



## Mark Applications Filed (Contd.)

(210) AP/M/2025/007501  
(220) 28.07.2025  
(511) Int. Cl. 31, 35, 42 and 44: TZ, UG, ZW  
(731) HENDRIX GENETICS B.V.  
(740) HONEY & BLANCKENBERG  
(814) TZ, UG, ZW

(540) **SASSO**



(210) AP/M/2025/007502  
(220) 29.07.2025  
(511) Int. Cl. 35: BW, CV, GM, LR, LS, MW, MZ, NA, ST, SZ, TZ, UG, ZW  
(731) ZIMBABWE INTERNATIONAL TRADE FAIR COMPANY  
(740) TSHUMA Innocent  
(814) BW, CV, GM, LR, LS, MW, MZ, NA, ST, SZ, TZ, UG, ZW

(540) **ZITF**



(210) AP/M/2025/007503  
(220) 29.07.2025  
(511) Int. Cl. 35 and 36: BW, CV, GM, LR, LS, MW, MZ, NA, ST, SZ, TZ, UG, ZW  
(731) ZIMBABWE INTERNATIONAL TRADE FAIR COMPANY  
(740) TSHUMA Innocent  
(814) BW, CV, GM, LR, LS, MW, MZ, NA, ST, SZ, TZ, UG, ZW

(540)



(210) AP/M/2025/007504  
(220) 29.07.2025  
(511) Int. Cl. 35: BW, CV, GM, LR, LS, MW, MZ, NA, ST, SZ, TZ, UG, ZW  
(731) ZIMBABWE INTERNATIONAL TRADE FAIR COMPANY  
(740) TSHUMA Innocent  
(814) BW, CV, GM, LR, LS, MW, MZ, NA, ST, SZ, TZ, UG, ZW

(540) **MINEENTRA**  
MINING. ENGINEERING & TRANSPORT EXPC



(210) AP/M/2025/007505  
(220) 29.07.2025  
(511) Int. Cl. 5: MW, TZ, ZW  
(731) NATIONAL AGRICULTURAL RESEARCH ORGANISATION  
(740) Nomad Advocates  
(814) MW, TZ, ZW

(540) **NAROVAC**



(210) AP/M/2025/007506  
(220) 29.07.2025  
(511) Int. Cl. 29: BW, MW  
(731) MEGA MARKET (PRIVATE) LIMITED  
(740) Gollop and Blank Legal Practitioners  
(814) BW, MW

(540)



(210) AP/M/2025/007507  
(220) 29.07.2025  
(511) Int. Cl. 29 and 30: BW, MW  
(731) MEGA MARKET (PRIVATE) LIMITED  
(740) Gollop and Blank Legal Practitioners  
(814) BW, MW

(540)



(210) AP/M/2025/007508  
(220) 29.07.2025  
(511) Int. Cl. 30: ZW  
(731) SHENZHEN BEST INVESTMENT CO., LTD.  
(740) M/S BIS ASSOCIATED ADVOCATES  
(814) ZW

(540)



(210) AP/M/2025/007509  
(220) 29.07.2025  
(511) Int. Cl. 30: BW, MW

(731) MEGA MARKET (PRIVATE) LIMITED  
(740) Gollop and Blank Legal Practitioners  
(814) BW, MW

(540)



(210) AP/M/2025/007510  
(220) 29.07.2025  
(511) Int. Cl. 16, 29, 30 and 34: BW, MW  
(731) MEGA MARKET (PRIVATE) LIMITED  
(740) Gollop and Blank Legal Practitioners  
(814) BW, MW

(540)



(210) AP/M/2025/007511  
(220) 29.07.2025  
(511) Int. Cl. 16, 29 and 30: BW, MW  
(731) MEGA MARKET (PRIVATE) LIMITED  
(740) Gollop and Blank Legal Practitioners  
(814) BW, MW

(540)



(210) AP/M/2025/007512  
(220) 29.07.2025  
(511) Int. Cl. 3, 29 and 30: BW, MW  
(731) MEGA MARKET (PRIVATE) LIMITED  
(740) Gollop and Blank Legal Practitioners  
(814) BW, MW

(540)



## Mark Applications Filed (Contd.)

(210) AP/M/2025/007513  
(220) 07.08.2025  
(511) Int. Cl. 30: BW, CV, GM, LR, LS, MW, MZ, NA, ST, SZ, UG, ZW  
(731) BAKHRESA HOLDINGS LTD.  
(740) LEXGLOBE LLP  
(814) BW, CV, GM, LR, LS, MW, MZ, NA, ST, SZ, UG, ZW

(540)



(210) AP/M/2025/007514  
(220) 29.07.2025  
(511) Int. Cl. 9: BW, CV, GM, LR, LS, MW, MZ, NA, ST, SZ, TZ, UG, ZW  
(731) HIKMA AL NUR TRADING LLC  
(740) Cronjé & Co.  
(814) BW, CV, GM, LR, LS, MW, MZ, NA, ST, SZ, TZ, UG, ZW

(540)



(210) AP/M/2025/007515  
(220) 29.07.2025  
(511) Int. Cl. 3 and 7: BW, NA, ZW  
(731) TVISION LIMITED  
(740) ENSafrica Namibia  
(814) BW, NA, ZW

(540) **SPONONO**



(210) AP/M/2025/007516  
(220) 31.07.2025  
(511) Int. Cl. 9, 36, 41 and 42: ZW  
(731) MBIRA Lenia  
(740) MBIRA Lenia  
(814) ZW

(540)



(210) AP/M/2025/007517  
(220) 31.07.2025  
(511) Int. Cl. 9, 35, 41 and 42: ZW  
(731) MBIRA Lenia  
(740) MBIRA Lenia  
(814) ZW

(540) **SHAYNUEL**



(210) AP/M/2025/007518  
(220) 31.07.2025  
(511) Int. Cl. 3 and 5: BW, CV, GM, LR, LS, MW, MZ, NA, ST, SZ, TZ, UG, ZW  
(731) MELANO PHARMA, LIMITED LIABILITY COMPANY  
(740) M/S BIS ASSOCIATED ADVOCATES  
(814) BW, CV, GM, LR, LS, MW, MZ, NA, ST, SZ, TZ, UG, ZW

(540) **MELANOFREE 4%**  
**میلانوفری ۴٪**



(210) AP/M/2025/007519  
(220) 29.07.2025  
(511) Int. Cl. 32: ZW  
(731) SWINKELS FAMILY BREWERS N.V.  
(740) MAWERE AND SIBANDA LEGAL PRACTITIONERS

(814) ZW

(540) **ZIMBO**



(210) AP/M/2025/007520  
(220) 31.07.2025  
(511) Int. Cl. 3 and 5: BW, CV, GM, LR, LS, MW, MZ, NA, ST, SZ, TZ, UG, ZW  
(731) MELANO PHARMA, LIMITED LIABILITY COMPANY  
(740) M/S BIS ASSOCIATED ADVOCATES  
(814) BW, CV, GM, LR, LS, MW, MZ, NA, ST, SZ, TZ, UG, ZW

(540) **میلانو فارما**



(210) AP/M/2025/007521  
(220) 30.07.2025  
(511) Int. Cl. 35: ZW  
(731) VILLAGE LIQUORS (PVT) LTD  
(740) AT MUZA ATTORNEYS  
(814) ZW

(540) **BARAZA**



(210) AP/M/2025/007522  
(220) 30.07.2025  
(511) Int. Cl. 29, 30, 32 and 35: BW, CV, GM, LR, LS, MW, MZ, NA, ST, SZ, TZ, UG, ZW  
(731) FOOD BABA GIDA TURIZM SANAYI VE DIŞ TICARET LIMITED ŞİRKETİ  
(740) KITAKA MARTIN  
(814) BW, CV, GM, LR, LS, MW, MZ, NA, ST, SZ, TZ, UG, ZW

(540)



**Marks Assigned**

(111) AP/M/2014/002210  
 (151) 13.03.2017  
 (220) 05.11.2014  
 (511) Int. Cl. 39: BW, ZW  
 (580) 18.07.2025  
 (731) UNIFREIGHT AFRICA LIMITED  
 (740) MAWERE AND SIBANDA LEGAL PRACTITIONERS  
 (814) BW, ZW

(540) **UNIFREIGHT**



(111) AP/M/2014/002211  
 (151) 27.03.2017  
 (220) 05.11.2014  
 (511) Int. Cl. 39: BW, ZW  
 (580) 18.07.2025  
 (731) UNIFREIGHT AFRICA LIMITED  
 (740) MAWERE AND SIBANDA LEGAL PRACTITIONERS  
 (814) BW, ZW

(540)



(111) AP/M/2014/002212  
 (151) 09.03.2017  
 (220) 05.11.2014  
 (511) Int. Cl. 39: BW, ZW  
 (580) 18.07.2025  
 (731) UNIFREIGHT AFRICA LIMITED  
 (740) MAWERE AND SIBANDA LEGAL PRACTITIONERS  
 (814) BW, ZW

(540) **BULWARK**



(111) AP/M/2014/002213  
 (151) 13.03.2017  
 (220) 05.11.2014  
 (511) Int. Cl. 39: BW, ZW  
 (580) 18.07.2025  
 (731) UNIFREIGHT AFRICA LIMITED  
 (740) MAWERE AND SIBANDA LEGAL PRACTITIONERS  
 (814) BW, ZW

(540)



(111) AP/M/2014/002214  
 (151) 25.01.2018  
 (220) 05.11.2014  
 (511) Int. Cl. 39: BW, ZW  
 (580) 18.07.2025  
 (731) UNIFREIGHT AFRICA LIMITED  
 (740) MAWERE AND SIBANDA LEGAL PRACTITIONERS  
 (814) BW, ZW

(540) **PIONEER CORPORATION AFRICA**



(111) AP/M/2014/002215  
 (151) 25.01.2018  
 (220) 05.11.2014  
 (511) Int. Cl. 39: BW, ZW  
 (580) 18.07.2025  
 (731) UNIFREIGHT AFRICA LIMITED  
 (740) MAWERE AND SIBANDA LEGAL PRACTITIONERS  
 (814) BW, ZW

(540)



(111) AP/M/2014/002216  
 (151) 09.03.2017  
 (220) 05.11.2014  
 (511) Int. Cl. 39: BW, ZW  
 (580) 18.07.2025  
 (731) UNIFREIGHT AFRICA LIMITED  
 (740) MAWERE AND SIBANDA LEGAL PRACTITIONERS  
 (814) BW, ZW

(540) **PIONEER TRANSPORT**



(111) AP/M/2014/002217  
 (151) 09.03.2017  
 (220) 05.11.2014  
 (511) Int. Cl. 39: BW, ZW  
 (580) 18.07.2025  
 (731) UNIFREIGHT AFRICA LIMITED

(740) MAWERE AND SIBANDA LEGAL PRACTITIONERS  
 (814) BW, ZW

(540)



(111) AP/M/2014/002218  
 (151) 25.01.2018  
 (220) 05.11.2014  
 (511) Int. Cl. 39: BW, ZW  
 (580) 18.07.2025  
 (731) UNIFREIGHT AFRICA LIMITED  
 (740) MAWERE AND SIBANDA LEGAL PRACTITIONERS  
 (814) BW, ZW

(540)



(111) AP/M/2014/002219  
 (151) 25.01.2018  
 (220) 05.11.2014  
 (511) Int. Cl. 39: BW, ZW  
 (580) 18.07.2025  
 (731) UNIFREIGHT AFRICA LIMITED  
 (740) MAWERE AND SIBANDA LEGAL PRACTITIONERS  
 (814) BW, ZW

(540) **1 - 4 - 5 CLUB**



(111) AP/M/2014/002220  
 (151) 25.01.2018  
 (220) 05.11.2014  
 (511) Int. Cl. 41: BW, ZW  
 (580) 18.07.2025  
 (731) UNIFREIGHT AFRICA LIMITED  
 (740) MAWERE AND SIBANDA LEGAL PRACTITIONERS  
 (814) BW, ZW

(540) **UNIFREIGHT DRIVER TRAINING**



**Marks  
Assigned  
(Contd.)**

(111) AP/M/2015/002285  
(151) 25.01.2018  
(220) 26.01.2015  
(511) Int. Cl. 39: BW, ZW  
(580) 18.07.2025  
(731) UNIFREIGHT AFRICA LIMITED  
(740) MAWERE AND SIBANDA LEGAL PRACTITIONERS  
(814) BW, ZW

(540) **SWIFT**



(111) AP/M/2015/002286  
(151) 24.03.2017  
(220) 26.01.2015  
(511) Int. Cl. 39: BW, ZW  
(580) 18.07.2025  
(731) UNIFREIGHT AFRICA LIMITED  
(740) MAWERE AND SIBANDA LEGAL PRACTITIONERS  
(814) BW, ZW

(540) **JUST SWIFT IT**



(111) AP/M/2015/002287  
(151) 26.09.2016  
(220) 26.01.2015  
(511) Int. Cl. 39: BW, ZW  
(580) 18.07.2025  
(731) UNIFREIGHT AFRICA LIMITED  
(740) MAWERE AND SIBANDA LEGAL PRACTITIONERS  
(814) BW, ZW

(540) **PIONEER COACHES**



(111) AP/M/2015/002288  
(151) 25.01.2018  
(220) 26.01.2015  
(511) Int. Cl. 39: BW, ZW  
(580) 18.07.2025  
(731) UNIFREIGHT AFRICA LIMITED  
(740) MAWERE AND SIBANDA LEGAL PRACTITIONERS  
(814) BW, ZW

(540) **BLUE ARROW**



(111) AP/M/2015/002289  
(151) 23.09.2016

(220) 26.01.2015  
(511) Int. Cl. 39: BW, ZW  
(580) 18.07.2025  
(731) UNIFREIGHT AFRICA LIMITED  
(740) MAWERE AND SIBANDA LEGAL PRACTITIONERS  
(814) BW, ZW



(111) AP/M/2015/002290  
(151) 23.03.2017  
(220) 26.01.2015  
(511) Int. Cl. 39: BW, ZW  
(580) 18.07.2025  
(731) UNIFREIGHT AFRICA LIMITED  
(740) MAWERE AND SIBANDA LEGAL PRACTITIONERS  
(814) BW, ZW



(111) AP/M/2015/002291  
(151) 25.01.2018  
(220) 26.01.2015  
(511) Int. Cl. 39: BW, ZW  
(580) 18.07.2025  
(731) UNIFREIGHT AFRICA LIMITED  
(740) MAWERE AND SIBANDA LEGAL PRACTITIONERS  
(814) BW, ZW



(111) AP/M/2015/002513  
(151) 28.05.2019  
(220) 04.11.2015  
(511) Int. Cl. 32: BW, LR, LS, MW, NA, SZ, TZ, UG, ZW  
(580) 01.11.2024  
(731) SOCIEDAD ANÓNIMA DAMM  
(740) HONEY & BLANCKENBERG  
(814) BW, LR, LS, MW, NA, SZ, TZ, UG, ZW

(540) **BRIZO**



(210) AP/M/2024/007013  
(220) 30.12.2024

(511) Int. Cl. 9: BW, CV, GM, LR, LS, MW, NA, ST, SZ, TZ, UG, ZW  
(580) 08.07.2025  
(731) INOI HOLDINGS LTD  
(740) Cronjé & Co.  
(814) BW, CV, GM, LR, LS, MW, NA, ST, SZ, TZ, UG, ZW



## Marks Pending Registration

(210) AP/M/2018/003452  
 (220) 26.07.2018  
 (511) Int. Cl. 6, 20 and 45: BW, LS, MW, MZ, NA, SZ, TZ, UG, ZW  
 (511) Int. Cl. 35, 36 and 44: BW, LS, MW, MZ, NA, SZ, TZ, UG  
 (731) FIRST MUTUAL HOLDINGS LIMITED  
 (740) GILL, GODLONTON & GERRANS  
 (814) BW, LS, MW, MZ, NA, SZ, TZ, UG, ZW

(540) **FIRST MUTUAL**  
 Go Beyond



(210) AP/M/2024/006318  
 (220) 09.01.2024  
 (511) Int. Cl. 7 and 17: BW, CV, GM, LR, LS, MW, MZ, NA, ST, SZ, TZ, UG, ZW  
 (731) MUHAMMAD Atif, MUHAMMAD Arif Abdul Aziz and MUHAMMAD Aquib  
 (740) Cronjé & Co.  
 (814) BW, CV, GM, LR, LS, MW, MZ, NA, ST, SZ, TZ, UG, ZW

(540) 



(210) AP/M/2024/006411  
 (220) 13.03.2024  
 (511) Int. Cl. 30: ZW  
 (731) BAKER ACRE INVESTMENTS (PRIVATE) LIMITED t/a PRINCE BISCUITS  
 (740) SCANLEN & HOLDERNESS  
 (814) ZW

(540) 



(210) AP/M/2024/006467  
 (220) 08.04.2024  
 (511) Int. Cl. 35: BW, CV, GM, LR, LS, MW, MZ, NA, ST, SZ, TZ, UG, ZW  
 (731) THE CHANTECAILLE CONSERVATION FOUNDATION  
 (740) D. K. MAKUBUYA ADVOCATES

(814) BW, CV, GM, LR, LS, MW, MZ, NA, ST, SZ, TZ, UG, ZW

(540) **ELEPHANT WAY**



(210) AP/M/2024/006505  
 (220) 06.05.2024  
 (511) Int. Cl. 35: ZW  
 (731) WEBDEV PRIVATE LIMITED  
 (740) WEBDEV PRIVATE LIMITED  
 (814) ZW

(540) **cars.co.zw**



(210) AP/M/2024/006513  
 (220) 09.05.2024  
 (511) Int. Cl. 37: ZW  
 (731) THE PROCLEAN COMPANY  
 (740) FERRAO LAW CHAMBERS  
 (814) ZW

(540) **PROCLEAN**



(210) AP/M/2024/006527  
 (220) 15.05.2024  
 (511) Int. Cl. 36, 41 and 44: CV, GM, LR, MZ, TZ, UG, ZW  
 (731) MALARIA PARTNERS INTERNATIONAL  
 (740) GILL, GODLONTON & GERRANS  
 (814) CV, GM, LR, MZ, TZ, UG, ZW

(540) 



(210) AP/M/2024/006528  
 (220) 15.05.2024  
 (511) Int. Cl. 36, 41 and 44: CV, GM, LR, MZ, TZ, UG, ZW  
 (731) MALARIA PARTNERS INTERNATIONAL  
 (740) GILL, GODLONTON & GERRANS  
 (814) CV, GM, LR, MZ, TZ, UG, ZW

(540) **MALARIA PARTNERS**



(210) AP/M/2024/006531  
 (220) 17.05.2024  
 (511) Int. Cl. 3, 16, 29, 30, 31, 32, 33 and 34: ZW  
 (731) NILEHILLS INVESTMENTS (PRIVATE) LIMITED  
 (740) MAFONGOYA Chido Pamela

(814) ZW

(540)



(210) AP/M/2024/006532  
 (220) 21.05.2024  
 (511) Int. Cl. 9 and 11: BW, CV, GM, LR, LS, MW, MZ, NA, ST, SZ, TZ, UG, ZW  
 (731) ALI BADI ELECTRONICS (LLC)  
 (740) Cronjé & Co.  
 (814) BW, CV, GM, LR, LS, MW, MZ, NA, ST, SZ, TZ, UG, ZW

(540)



(210) AP/M/2024/006569  
 (220) 12.06.2024  
 (511) Int. Cl. 19 and 35: BW, MZ, NA, ZW  
 (511) Int. Cl. 37: BW, MZ, NA  
 (731) INTER-AFRICA CIVILS, A PRIVATE COMPANY LIMITED BY SHARES  
 (740) GILL, GODLONTON & GERRANS  
 (814) BW, MZ, NA, ZW

(540)



(210) AP/M/2024/006598  
 (220) 24.06.2024  
 (511) Int. Cl. 10: BW, CV, GM, LR, LS, MW, MZ, NA, ST, SZ, TZ, UG, ZW  
 (731) RETRACTABLE TECHNOLOGIES, INC.  
 (740) GALLOWAY & COMPANY  
 (814) BW, CV, GM, LR, LS, MW, MZ, NA, ST, SZ, TZ, UG, ZW

(540) **DOSE INDICATOR**



## Marks Pending Registration (Contd.)

(210) AP/M/2024/006624

(220) 09.07.2024

(511) Int. Cl. 41: ZW

(731) MAYANJA FAMILY TRUST

(740) MAYANJA FAMILY TRUST

(814) ZW

(540)



RIVERSIDE SCHOOL



(210) AP/M/2024/006627

(220) 10.07.2024

(511) Int. Cl. 1 and 19: BW, MW, MZ, NA, ZW

(731) STUMBELBLOC ZIMBABWE (PVT) LIMITED

(740) AT MUZA ATTORNEYS

(814) BW, MW, MZ, NA, ZW

(540) **BLOCK GRIP**

(210) AP/M/2024/006641

(220) 15.07.2024

(511) Int. Cl. 41: ZW

(731) BALOYI Sherman

(740) TAKUNDWA MBEREKO ATTORNEYS

(814) ZW

(540)

**onaso** 



(210) AP/M/2024/006685

(220) 14.08.2024

(511) Int. Cl. 9, 38 and 42: BW, CV, GM, LR, LS, MW, MZ, NA, ST, SZ, TZ, UG, ZW

(731) ITRON, INC.

(740) AT MUZA ATTORNEYS

(814) BW, CV, GM, LR, LS, MW, MZ, NA, ST, SZ, TZ, UG, ZW

(540)

**Itron** 



(210) AP/M/2024/006704

(220) 20.08.2024

(511) Int. Cl. 36: BW, LS, MW, MZ, SZ, TZ, ZW

(731) SIA ECFG

(740) Cronjé &amp; Co.

(814) BW, LS, MW, MZ, SZ, TZ, ZW

(540)





(210) AP/M/2024/006711

(220) 22.08.2024

(511) Int. Cl. 3, 25 and 35: TZ, UG

(731) ZHAO Chuqiang

(740) M/S BIS ASSOCIATED ADVOCATES

(814) TZ, UG

(540)



**petergiant**



(210) AP/M/2024/006723

(220) 29.08.2024

(511) Int. Cl. 5: GM, TZ, UG

(731) ZHEJIANG LAMKING BIOTECHNOLOGY CO.,LTD

(740) CRYSTAL LEGAL ASSOCIATES

(814) GM, TZ, UG

(540)



(210) AP/M/2024/006725

(220) 29.08.2024

(511) Int. Cl. 25: MZ

(731) AMADE Neuza

(740) ROLAND INTELLECTUAL PROPERTY CONSULTANTS

(814) MZ

(540) **MZIK**

(210) AP/M/2024/006739

(220) 05.09.2024

(511) Int. Cl. 9: BW, CV, GM, LR, LS, MW, MZ, NA, ST, SZ, TZ, UG, ZW

(731) M/S ERD TECHNOLOGIES PVT. LTD.

(740) Cronjé &amp; Co.

(814) BW, CV, GM, LR, LS, MW, MZ, NA, ST, SZ, TZ, UG, ZW

(540)





(210) AP/M/2024/006746

(220) 09.09.2024

(511) Int. Cl. 3: BW, CV, GM, LR, LS, MW, MZ, NA, ST, SZ, TZ, UG, ZW

(731) STERLING PERFUMES INDUSTRIES (L.L.C.)

(740) Cronjé &amp; Co.

(814) BW, CV, GM, LR, LS, MW, MZ, NA, ST, SZ, TZ, UG, ZW

(540)





(210) AP/M/2024/006747

(220) 09.09.2024

(511) Int. Cl. 3: BW, CV, GM, LR, LS, MW, MZ, NA, ST, SZ, TZ, UG, ZW

(731) STERLING PERFUMES INDUSTRIES (L.L.C.)

(740) Cronjé &amp; Co.

(814) BW, CV, GM, LR, LS, MW, MZ, NA, ST, SZ, TZ, UG, ZW

(540)





(210) AP/M/2024/006750

(220) 10.09.2024

(511) Int. Cl. 5: BW, LR, MW, MZ, NA, TZ, UG, ZW

(731) BLISS GVS PHARMA LTD

(740) HUSSEIN &amp; Co.

(814) BW, LR, MW, MZ, NA, TZ, UG, ZW

(540) **AMONART**

## Marks Pending Registration (Contd.)

(210) AP/M/2024/006751  
(220) 10.09.2024  
(511) Int. Cl. 5: BW, LR, MW, MZ, NA, TZ, UG, ZW

(731) BLISS GVS PHARMA LTD  
(740) HUSSEIN & Co.  
(814) BW, LR, MW, MZ, NA, TZ, UG, ZW

(540) **PALUDOXIN**



(210) AP/M/2024/006752  
(220) 10.09.2024  
(511) Int. Cl. 5: BW, LR, MW, MZ, NA, TZ, UG, ZW

(731) BLISS GVS PHARMA LTD  
(740) HUSSEIN & Co.  
(814) BW, LR, MW, MZ, NA, TZ, UG, ZW

(540) **ZIRIFY**



(210) AP/M/2024/006753  
(220) 10.09.2024  
(511) Int. Cl. 5: BW, LR, MW, MZ, NA, TZ, UG, ZW

(731) BLISS GVS PHARMA LTD  
(740) HUSSEIN & Co.  
(814) BW, LR, MW, MZ, NA, TZ, UG, ZW

(540) **ROXUTIN**



(210) AP/M/2024/006754  
(220) 10.09.2024  
(511) Int. Cl. 5: BW, LR, MW, MZ, NA, TZ, UG, ZW

(731) BLISS GVS PHARMA LTD  
(740) HUSSEIN & Co.  
(814) BW, LR, MW, MZ, NA, TZ, UG, ZW

(540) **BIXO**



(210) AP/M/2024/006755  
(220) 10.09.2024  
(511) Int. Cl. 5: BW, LR, MW, MZ, NA, TZ, UG, ZW

(731) BLISS GVS PHARMA LTD  
(740) HUSSEIN & Co.  
(814) BW, LR, MW, MZ, NA, TZ, UG, ZW

(540) **LOPINE**



(210) AP/M/2024/006758  
(220) 11.09.2024  
(511) Int. Cl. 30: MW, MZ, ZW  
(731) TRADE KINGS LIMITED  
(740) TRADE KINGS ZIMBABWE (PVT.) LIMITED  
(814) MW, MZ, ZW

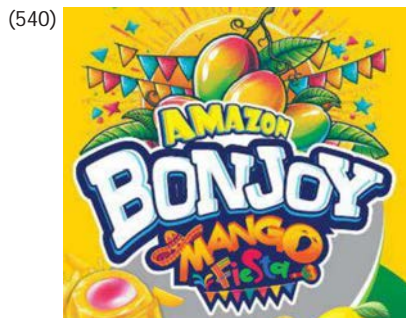

(210) AP/M/2024/006759  
(220) 12.09.2024  
(511) Int. Cl. 12: UG  
(731) BRISA BRIDGESTONE SABANCI LASTIK SANAYI VE TICARET ANONIM SIRKETI  
(740) INVENTA MOZAMBIQUE, LDA.  
(814) UG

(540) 



(210) AP/M/2024/006762  
(220) 13.09.2024  
(511) Int. Cl. 5 and 16: BW, MW, MZ, NA, TZ, ZW  
(731) YO' CARE HYGIENICS LIMITED  
(740) YO BRANDS PRIVATE LIMITED  
(814) BW, MW, MZ, NA, TZ, ZW



(210) AP/M/2024/006763  
(220) 13.09.2024  
(511) Int. Cl. 29 and 30: BW, MW, MZ, NA, TZ, ZW  
(731) YOYO FOODS LIMITED  
(740) YO BRANDS PRIVATE LIMITED  
(814) BW, MW, MZ, NA, TZ, ZW

(540) **FILLZ**



(210) AP/M/2024/006764  
(220) 13.09.2024  
(511) Int. Cl. 29 and 30: BW, MW, MZ, NA, TZ, ZW  
(731) YOYO FOODS LIMITED  
(740) YO BRANDS PRIVATE LIMITED  
(814) BW, MW, MZ, NA, TZ, ZW

(540) **PILLOWZ**



(210) AP/M/2024/006767  
(220) 16.09.2024  
(511) Int. Cl. 9, 35, 38 and 42: BW, NA  
(731) MTN GROUP MANAGEMENT SERVICES (PROPRIETARY) LIMITED  
(740) ENSAfrica Namibia  
(814) BW, NA

(540) **MTN ADS**



(210) AP/M/2024/006769  
(220) 18.09.2024  
(511) Int. Cl. 25: ZW  
(731) ZHU Xiachen  
(740) SCANLEN & HOLDERNESS  
(814) ZW

(540) 



(210) AP/M/2024/006770  
(220) 19.09.2024  
(511) Int. Cl. 9, 11, 35, 37 and 42: ZW  
(731) BRIEFTECH INVESTMENTS (PRIVATE) LIMITED T/A SOLARPRO ZIMBABWE  
(740) B MATANGA IP ATTORNEYS  
(814) ZW

(540) 



## Marks Pending Registration (Contd.)

(210) AP/M/2024/006772

(220) 20.09.2024

(511) Int. Cl. 5: BW, CV, GM, LR, LS, MW, MZ, NA, ST, SZ, TZ, UG, ZW

(731) SHREE DWARIKADHISH VENTURES LLP

(740) B. W. KAHARI LEGAL PRACTITIONERS

(814) BW, CV, GM, LR, LS, MW, MZ, NA, ST, SZ, TZ, UG, ZW

(540)



••

(210) AP/M/2024/006773

(220) 20.09.2024

(511) Int. Cl. 3: BW, CV, GM, LR, LS, MW, MZ, NA, ST, SZ, TZ, UG, ZW

(731) SHREE DWARIKADHISH VENTURES LLP

(740) B. W. KAHARI LEGAL PRACTITIONERS

(814) BW, CV, GM, LR, LS, MW, MZ, NA, ST, SZ, TZ, UG, ZW

(540)

# Charm & Glow

••

(210) AP/M/2024/006774

(220) 23.09.2024

(511) Int. Cl. 9: UG

(731) YIWU LIXIANG BATTERY CO., LTD

(740) D'ALMEIDA NIDIA

(814) UG

(540)

# Pluto

••

(210) AP/M/2024/006775

(220) 23.09.2024

(511) Int. Cl. 3: BW, CV, GM, LR, LS, MW, MZ, NA, ST, SZ, TZ, UG, ZW

(731) AMINA LIMITED

(740) HUSSEIN &amp; Co.

(814) BW, CV, GM, LR, LS, MW, MZ, NA, ST, SZ, TZ, UG, ZW

(540)



••

(210) AP/M/2024/006779

(220) 23.09.2024

(511) Int. Cl. 1, 6, 7, 9, 11, 19, 20 and 21: BW, LS, MZ, NA, SZ, ZW

(731) LEANDER GROUP PROPRIETARY LIMITED

(740) ENSafrica Namibia

(814) BW, LS, MZ, NA, SZ, ZW

(540)



••

(210) AP/M/2024/006787

(220) 26.09.2024

(511) Int. Cl. 25, 39 and 43: BW, NA, ZW

(731) GONDWANA COLLECTIONS NAMIBIA (PTY) LTD

(740) FISHER, QUARMBY &amp; PFEIFER ATTORNEYS

(814) BW, NA, ZW

(540) **CAMPING2GO**

••

(210) AP/M/2024/006788

(220) 26.09.2024

(511) Int. Cl. 25, 39 and 43: BW, NA, ZW

(731) GONDWANA COLLECTIONS NAMIBIA (PTY) LTD

(740) FISHER, QUARMBY &amp; PFEIFER ATTORNEYS

(814) BW, NA, ZW

(540) **GO2 TRAVELLER TRANSFERS**

••

(210) AP/M/2024/006789

(220) 26.09.2024

(511) Int. Cl. 25, 39 and 43: BW, NA, ZW

(731) GONDWANA COLLECTIONS NAMIBIA (PTY) LTD

(740) FISHER, QUARMBY &amp; PFEIFER ATTORNEYS

(814) BW, NA, ZW

(540)



••

(210) AP/M/2024/006790

(220) 26.09.2024

(511) Int. Cl. 3: BW, GM, LR, LS, MW, MZ, NA, ST, SZ, TZ, UG, ZW

(731) NISHAAN John Dilip Dodani

(740) Cronjé &amp; Co.

(814) BW, GM, LR, LS, MW, MZ, NA, ST, SZ, TZ, UG, ZW

(540) **MYKONOS**

••

(210) AP/M/2024/006793

(220) 26.09.2024

(511) Int. Cl. 3: BW, CV, GM, LR, LS, MW, MZ, NA, ST, SZ, TZ, UG, ZW

(731) AMINA LIMITED

(740) HUSSEIN &amp; Co.

(814) BW, CV, GM, LR, LS, MW, MZ, NA, ST, SZ, TZ, UG, ZW

(540) **Bounce & Beautiful**

••

(210) AP/M/2024/006794

(220) 26.09.2024

(511) Int. Cl. 25, 39 and 43: BW, NA, ZW

(731) GONDWANA COLLECTIONS NAMIBIA (PTY) LTD

(740) FISHER, QUARMBY &amp; PFEIFER ATTORNEYS

(814) BW, NA, ZW

(540) **NAMIBIA2GO**

••

(210) AP/M/2024/006795

(220) 27.09.2024

(511) Int. Cl. 35: ZW

(731) ENTREPRENEURS NETWORK ASSOCIATION OF ZIMBABWE (ENAZ)

(740) KASEKE K .T Nigel

(814) ZW

(540)

**BUSINESS INVESTMENT  
EXPO**

••



**Marks Pending  
Registration  
(Contd.)**

(210) AP/M/2024/006796  
(220) 27.09.2024  
(511) Int. Cl. 12: BW, CV, GM, LR, LS, MW, MZ, NA, ST, SZ, TZ, UG, ZW  
(731) VOLVO BUS CORPORATION  
(740) B MATANGA IP ATTORNEYS  
(814) BW, CV, GM, LR, LS, MW, MZ, NA, ST, SZ, TZ, UG, ZW

(540) **B8F**



(210) AP/M/2024/006802  
(220) 27.09.2024  
(511) Int. Cl. 4, 35, 36 and 39: BW, LR, MW, MZ, NA, ZW  
(731) MOCOH SA  
(740) ROLAND INTELLECTUAL PROPERTY CONSULTANTS  
(814) BW, LR, MW, MZ, NA, ZW

(540)



(210) AP/M/2024/006803  
(220) 30.09.2024  
(511) Int. Cl. 25, 39 and 43: BW  
(731) GONDWANA COLLECTIONS NAMIBIA (PTY) LTD  
(740) FISHER, QUARMBY & PFEIFER ATTORNEYS  
(814) BW

(540)



(210) AP/M/2024/006804  
(220) 30.09.2024  
(511) Int. Cl. 25, 39 and 43: NA  
(731) GONDWANA COLLECTIONS NAMIBIA (PTY) LTD  
(740) FISHER, QUARMBY & PFEIFER ATTORNEYS  
(814) NA

(540)



(210) AP/M/2024/006806  
(220) 30.09.2024  
(511) Int. Cl. 25, 39 and 43: ZW  
(731) GONDWANA COLLECTIONS NAMIBIA (PTY) LTD  
(740) FISHER, QUARMBY & PFEIFER ATTORNEYS

(814) ZW

(540)



(210) AP/M/2024/006820  
(220) 08.10.2024  
(511) Int. Cl. 9, 36 and 42: BW, MZ, NA, TZ, ZW  
(731) ICE IP LIMITED  
(740) Cronjé & Co.  
(814) BW, MZ, NA, TZ, ZW

(540)



(210) AP/M/2024/006821  
(220) 08.10.2024  
(511) Int. Cl. 34: BW, CV, GM, LR, LS, MW, MZ, NA, ST, SZ, TZ, UG, ZW  
(731) BEST TOBACCO COMPANY (PTY) LTD  
(740) Cronjé & Co.  
(814) BW, CV, GM, LR, LS, MW, MZ, NA, ST, SZ, TZ, UG, ZW

(540) **CARTEL**



(210) AP/M/2024/006822  
(220) 08.10.2024  
(511) Int. Cl. 34: BW, CV, GM, LR, LS, MW, MZ, NA, ST, SZ, TZ, UG, ZW  
(731) BEST TOBACCO COMPANY (PTY) LTD  
(740) Cronjé & Co.  
(814) BW, CV, GM, LR, LS, MW, MZ, NA, ST, SZ, TZ, UG, ZW

(540)



(210) AP/M/2024/006837  
(220) 14.10.2024  
(511) Int. Cl. 5: BW, CV, GM, LR, LS, MW, MZ, NA, ST, SZ, TZ, UG, ZW  
(731) FOSUN PHARMA SAS  
(740) Eden Law Chambers  
(814) BW, CV, GM, LR, LS, MW, MZ, NA, ST, SZ, TZ, UG, ZW

(540) **WANSUGINE**



## Marks Registered

(111) AP/M/2015/002296  
(151) 08.07.2025  
(220) 02.02.2015  
(511) Int. Cl. 35 and 39: BW, LR, LS, NA, SZ, TZ, UG, ZW  
(731) QATAR COMPANY FOR AIRPORTS OPERATION AND MANAGEMENT  
(740) FISHER CORMACK & BOTHA  
(814) BW, LR, LS, NA, SZ, TZ, UG, ZW

(540)



••

(111) AP/M/2022/005438  
(151) 29.07.2025  
(220) 21.11.2022  
(511) Int. Cl. 25: BW, CV, GM, LR, LS, MW, MZ, NA, ST, SZ, TZ, UG, ZW  
(731) QF TRADING LLP  
(740) PALLADIUM STRATEGY & IP CONSULTANTS  
(814) BW, CV, GM, LR, LS, MW, MZ, NA, ST, SZ, TZ, UG, ZW

(540)



••

(111) AP/M/2022/005439  
(151) 29.07.2025  
(220) 21.11.2022  
(511) Int. Cl. 25: BW, CV, GM, LR, LS, MW, MZ, NA, ST, SZ, TZ, UG, ZW  
(731) QF TRADING LLP  
(740) PALLADIUM STRATEGY & IP CONSULTANTS  
(814) BW, CV, GM, LR, LS, MW, MZ, NA, ST, SZ, TZ, UG, ZW

(540)



••

(111) AP/M/2023/005660  
(151) 31.07.2025  
(220) 23.02.2023  
(511) Int. Cl. 9, 35, 36, 37, 40 and 42: BW, CV, GM, LR, LS, MW, MZ, NA, ST, SZ, TZ, UG, ZW  
(731) SMA SOLAR TECHNOLOGY AG  
(740) INVENTA MOZAMBIQUE, LDA.  
(814) BW, CV, GM, LR, LS, MW, MZ, NA, ST, SZ, TZ, UG, ZW

(540) **ALTENSO**

••

(111) AP/M/2023/005879  
(151) 11.07.2025  
(220) 26.06.2023  
(511) Int. Cl. 9: TZ, UG  
(731) SHENZHEN WENJOY TECHNOLOGY CO.,LTD.  
(740) Cronjé & Co.

(814) TZ, UG

(540) **Telzeal**

••

(111) AP/M/2023/005910  
(151) 11.07.2025  
(220) 13.07.2023  
(511) Int. Cl. 5: TZ, UG  
(731) HEALTHBIOTICS LTD  
(740) Cronjé & Co.  
(814) TZ, UG

(540) **Minadex**

••

(111) AP/M/2023/006034  
(151) 11.07.2025  
(220) 04.09.2023  
(511) Int. Cl. 11: TZ, UG, ZW  
(731) ZHONGSHAN QCWOLVES LIGHTING TECHNOLOGY CO., LTD  
(740) Cronjé & Co.  
(814) TZ, UG, ZW

(540) **QCWOLVES**

••

(111) AP/M/2023/006055  
(151) 18.07.2025  
(220) 06.09.2023  
(511) Int. Cl. 36, 37, 40 and 42: BW, CV, GM, LR, LS, MW, MZ, NA, ST, SZ, TZ, UG, ZW  
(731) MANARA MINERALS INVESTMENT COMPANY  
(740) B. W. KAHARI LEGAL PRACTITIONERS  
(814) BW, CV, GM, LR, LS, MW, MZ, NA, ST, SZ, TZ, UG, ZW

(540)



••

(111) AP/M/2023/006121  
(151) 10.07.2025  
(220) 29.09.2023  
(511) Int. Cl. 9: BW, CV, GM, LR, LS, MW, MZ, NA, ST, SZ, TZ, UG, ZW  
(731) TLM INTERNATIONAL FZE  
(740) AT MUZA ATTORNEYS  
(814) BW, CV, GM, LR, LS, MW, MZ, NA, ST, SZ, TZ, UG, ZW

(540)



••

(111) AP/M/2023/006136  
(151) 11.07.2025  
(220) 04.10.2023  
(511) Int. Cl. 8: BW, NA  
(731) WAHL CLIPPER CORPORATION (CORPORATION OF ILLINOIS, USA)  
(740) AT MUZA ATTORNEYS  
(814) BW, NA

(540) **PRO SHAVE**

••

(111) AP/M/2023/006194  
(151) 10.07.2025  
(220) 31.10.2023  
(511) Int. Cl. 6 and 37: ST, SZ, TZ, ZW  
(731) KIRBY BUILDING SYSTEMS KUWAIT (S.A.K CLOSED)  
(740) B. W. KAHARI LEGAL PRACTITIONERS  
(814) ST, SZ, TZ, ZW

(540)



••

## Marks Registered (Contd.)

- (111) AP/M/2023/006196  
(151) 24.07.2025  
(220) 01.11.2023  
(511) Int. Cl. 29: BW, CV, GM, LR, LS, MW, MZ, NA, ST, SZ, TZ, UG, ZW  
(731) AL EKHWA AL MOTAHEDON FOR IMPORT & EXPORT  
(740) FISHER CORMACK & BOTHA  
(814) BW, CV, GM, LR, LS, MW, MZ, NA, ST, SZ, TZ, UG, ZW



- (111) AP/M/2023/006197  
(151) 01.07.2025  
(220) 01.11.2023  
(511) Int. Cl. 6: ZW  
(731) SUPER SMELTERS  
(740) Ranchhod Associates  
(814) ZW



- (111) AP/M/2024/006314  
(151) 18.07.2025  
(220) 05.01.2024  
(511) Int. Cl. 8: BW, NA  
(731) WAHL CLIPPER CORPORATION  
(740) AT MUZA ATTORNEYS  
(814) BW, NA

### (540) MANSCAPER

- (111) AP/M/2024/006323  
(151) 08.07.2025  
(220) 16.01.2024  
(511) Int. Cl. 12: BW, CV, GM, LR, LS, MW, MZ, NA, ST, SZ, UG, ZW  
(731) GUANGZHOU SINCERITY HOLDINGS CO., LTD.  
(740) INVENTA MOZAMBIQUE, LDA.  
(814) BW, CV, GM, LR, LS, MW, MZ, NA, ST, SZ, UG, ZW

### (540) APSONIC

- (111) AP/M/2024/006394  
(151) 31.07.2025  
(220) 29.02.2024  
(511) Int. Cl. 5: ZW  
(731) RUSAN PHARMA LIMITED  
(740) Phiri Nobert  
(814) ZW

### (540) BIORAN

- (111) AP/M/2024/006405  
(151) 03.07.2025  
(220) 05.03.2024  
(511) Int. Cl. 21: BW, CV, GM, LR, LS, MW, MZ, NA, ST, SZ, TZ, UG, ZW  
(731) INTELLIGENT HOMEWARE  
(740) B. W. KAHARI LEGAL PRACTITIONERS  
(814) BW, CV, GM, LR, LS, MW, MZ, NA, ST, SZ, TZ, UG, ZW

### (540) MILTON

- (111) AP/M/2024/006422  
(151) 11.07.2025  
(220) 19.03.2024  
(511) Int. Cl. 9 and 35: TZ, UG  
(731) GUO Liwan  
(740) Cronjé & Co.  
(814) TZ, UG

### (540) LISITONG

- (111) AP/M/2024/006423  
(151) 29.07.2025  
(220) 19.03.2024  
(511) Int. Cl. 5: BW, MZ, NA  
(731) GETZ PHARMA INTERNATIONAL FZ-LLC  
(740) Cronjé & Co.  
(814) BW, MZ, NA

### (540) PANTRA PLUS

- (111) AP/M/2024/006436  
(151) 31.07.2025  
(220) 22.03.2024  
(511) Int. Cl. 3: BW, LR, LS, MW, NA, ST, SZ, TZ, UG, ZW  
(731) REEF PERFUMES TRADING COMPANY  
(740) HONEY & BLANCKENBERG  
(814) BW, LR, LS, MW, NA, ST, SZ, TZ, UG, ZW

(540)



- (111) AP/M/2024/006441  
(151) 02.07.2025  
(220) 26.03.2024  
(511) Int. Cl. 5: BW, LS, MZ, NA, SZ, ZW  
(731) POPULATION SERVICES INTERNATIONAL  
(740) GILL, GODLONTON & GERRANS  
(814) BW, LS, MZ, NA, SZ, ZW

### (540) Arousa

- (111) AP/M/2024/006443  
(151) 24.07.2025  
(220) 26.03.2024  
(511) Int. Cl. 5: BW, LS, MZ, NA, SZ, ZW  
(731) POPULATION SERVICES INTERNATIONAL  
(740) GILL, GODLONTON & GERRANS  
(814) BW, LS, MZ, NA, SZ, ZW

### (540) Lovers+

- (111) AP/M/2024/006444  
(151) 29.07.2025  
(220) 26.03.2024  
(511) Int. Cl. 43: BW, CV, GM, LR, LS, MW, MZ, NA, ST, SZ, TZ, UG, ZW  
(731) FIND SALT OWNED BY INDEPENDENT RESTAURANTS MANAGEMENT ONE PERSON COMPANY LLC  
(740) PALLADIUM STRATEGY & IP CONSULTANTS  
(814) BW, CV, GM, LR, LS, MW, MZ, NA, ST, SZ, TZ, UG, ZW

(540)



**Marks  
Registered  
(Contd.)**

(111) AP/M/2024/006445  
(151) 29.07.2025  
(220) 26.03.2024  
(511) Int. Cl. 43: BW, CV, GM, LR, LS, MW, MZ, NA, ST, SZ, TZ, UG, ZW  
(731) FIND SALT OWNED BY INDEPENDENT RESTAURANTS MANAGEMENT ONE PERSON COMPANY LLC  
(740) PALLADIUM STRATEGY & IP CONSULTANTS  
(814) BW, CV, GM, LR, LS, MW, MZ, NA, ST, SZ, TZ, UG, ZW



(111) AP/M/2024/006446  
(151) 29.07.2025  
(220) 26.03.2024  
(511) Int. Cl. 43: BW, CV, GM, LR, LS, MW, MZ, NA, ST, SZ, TZ, UG, ZW  
(731) FIND SALT OWNED BY INDEPENDENT RESTAURANTS MANAGEMENT ONE PERSON COMPANY LLC  
(740) PALLADIUM STRATEGY & IP CONSULTANTS  
(814) BW, CV, GM, LR, LS, MW, MZ, NA, ST, SZ, TZ, UG, ZW



(111) AP/M/2024/006449  
(151) 11.07.2025  
(220) 02.04.2024  
(511) Int. Cl. 32 and 34: BW, MW, MZ, NA, ZW  
(731) JIBIAR SA  
(740) ENSAfrica Namibia  
(814) BW, MW, MZ, NA, ZW



(111) AP/M/2024/006453  
(151) 31.07.2025  
(220) 02.04.2024

(511) Int. Cl. 35: BW, LR, MW, NA  
(731) WORLD TRADE CENTERS ASSOCIATION, INC.  
(740) SAMURIWO ATTORNEYS  
(814) BW, LR, MW, NA



(111) AP/M/2024/006454  
(151) 31.07.2025  
(220) 02.04.2024  
(511) Int. Cl. 35: BW, LR, MW, NA  
(731) WORLD TRADE CENTERS ASSOCIATION, INC.  
(740) SAMURIWO ATTORNEYS  
(814) BW, LR, MW, NA



(111) AP/M/2024/006455  
(151) 31.07.2025  
(220) 02.04.2024  
(511) Int. Cl. 35: BW, LR, MW, NA  
(731) WORLD TRADE CENTERS ASSOCIATION, INC.  
(740) SAMURIWO ATTORNEYS  
(814) BW, LR, MW, NA



(111) AP/M/2024/006457  
(151) 18.07.2025  
(220) 03.04.2024  
(511) Int. Cl. 9, 28, 38 and 42: BW, CV, MW, MZ, NA, ST, ZW  
(731) PICO TECHNOLOGY CO., LTD.  
(740) FISHER CORMACK & BOTHA  
(814) BW, CV, MW, MZ, NA, ST, ZW



(111) AP/M/2024/006463  
(151) 03.07.2025  
(220) 08.04.2024  
(511) Int. Cl. 25: ZW  
(731) THE SUITS WORLD  
(740) THE SUITS WORLD  
(814) ZW

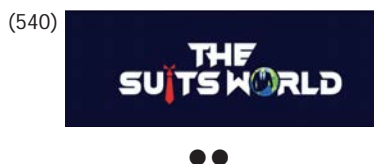

(111) AP/M/2024/006473  
(151) 31.07.2025  
(220) 10.04.2024  
(511) Int. Cl. 9: BW, MW, MZ, NA, TZ, UG, ZW  
(731) NEMTEK (PTY) LTD  
(740) HONEY & BLANCKENBERG  
(814) BW, MW, MZ, NA, TZ, UG, ZW



(111) AP/M/2024/006477  
(151) 31.07.2025  
(220) 12.04.2024  
(511) Int. Cl. 3: BW, CV, GM, LR, LS, MW, MZ, NA, ST, SZ, TZ, UG, ZW  
(731) LABORATOIRES M&L  
(740) HONEY & BLANCKENBERG  
(814) BW, CV, GM, LR, LS, MW, MZ, NA, ST, SZ, TZ, UG, ZW

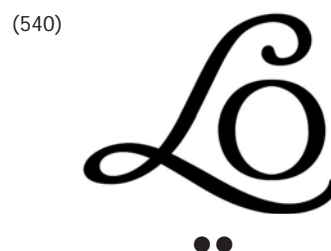

(111) AP/M/2024/006483  
(151) 11.07.2025  
(220) 19.04.2024  
(511) Int. Cl. 3: BW, CV, GM, LR, LS, MW, MZ, NA, ST, SZ, TZ, UG, ZW  
(731) GULF ORCHID PERFUME MANUFACTURING L.L.C.  
(740) Cronjé & Co.  
(814) BW, CV, GM, LR, LS, MW, MZ, NA, ST, SZ, TZ, UG, ZW



**Marks  
Registered  
(Contd.)**

(111) AP/M/2024/006484  
(151) 11.07.2025  
(220) 19.04.2024  
(511) Int. Cl. 3: BW, CV, GM, LR, LS, MW, MZ, NA, ST, SZ, TZ, UG, ZW  
(731) GULF ORCHID PERFUME MANUFACTURING L.L.C.  
(740) Cronjé & Co.  
(814) BW, CV, GM, LR, LS, MW, MZ, NA, ST, SZ, TZ, UG, ZW



(111) AP/M/2024/006485  
(151) 11.07.2025  
(220) 19.04.2024  
(511) Int. Cl. 3: BW, CV, GM, LR, LS, MW, MZ, NA, ST, SZ, TZ, UG, ZW  
(731) GULF ORCHID PERFUME MANUFACTURING L.L.C.  
(740) Cronjé & Co.  
(814) BW, CV, GM, LR, LS, MW, MZ, NA, ST, SZ, TZ, UG, ZW

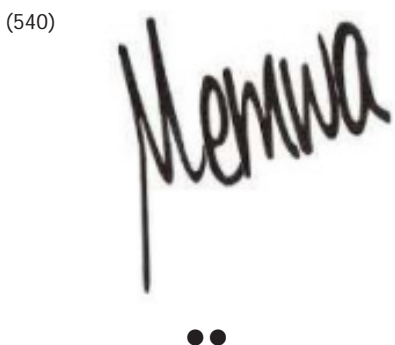

(111) AP/M/2024/006487  
(151) 11.07.2025  
(220) 23.04.2024  
(511) Int. Cl. 41: BW, LS, MW, MZ, NA, SZ, TZ, ZW  
(731) THE SOUTH AFRICAN INSTITUTION OF CIVIL ENGINEERING NPO  
(740) Cronjé & Co.  
(814) BW, LS, MW, MZ, NA, SZ, TZ, ZW



(111) AP/M/2024/006488  
(151) 11.07.2025  
(220) 23.04.2024  
(511) Int. Cl. 41: BW, LS, MW, MZ, NA, SZ, TZ, ZW  
(731) THE SOUTH AFRICAN INSTITUTION OF CIVIL ENGINEERING NPO  
(740) Cronjé & Co.  
(814) BW, LS, MW, MZ, NA, SZ, TZ, ZW



(111) AP/M/2024/006489  
(151) 11.07.2025  
(220) 23.04.2024  
(511) Int. Cl. 16, 35 and 41: BW, LS, MW, MZ, NA, SZ, TZ, ZW  
(731) THE SOUTH AFRICAN INSTITUTION OF CIVIL ENGINEERING NPO  
(740) Cronjé & Co.  
(814) BW, LS, MW, MZ, NA, SZ, TZ, ZW



(111) AP/M/2024/006490  
(151) 11.07.2025  
(220) 23.04.2024  
(511) Int. Cl. 16, 35 and 41: BW, LS, MW, MZ, NA, SZ, TZ, ZW  
(731) THE SOUTH AFRICAN INSTITUTION OF CIVIL ENGINEERING NPO  
(740) Cronjé & Co.  
(814) BW, LS, MW, MZ, NA, SZ, TZ, ZW

(540) **SAICE**

••

(111) AP/M/2024/006501  
(151) 29.07.2025  
(220) 02.05.2024  
(511) Int. Cl. 9, 11 and 35: MW, MZ, UG, ZW  
(731) HUANG Liang  
(740) Cronjé & Co.  
(814) MW, MZ, UG, ZW



(111) AP/M/2024/006518  
(151) 31.07.2025  
(220) 10.05.2024  
(511) Int. Cl. 29: BW, CV, GM, LR, LS, MW, MZ, NA, ST, SZ, TZ, UG, ZW  
(731) MAHER Hajj Ali  
(740) HUSSEIN & Co.  
(814) BW, CV, GM, LR, LS, MW, MZ, NA, ST, SZ, TZ, UG, ZW



(111) AP/M/2024/006519  
(151) 31.07.2025  
(220) 13.05.2024  
(511) Int. Cl. 1: MZ, TZ, UG  
(731) ZHEJIANG JIUERJIU CHEMICALS CO.,LTD.  
(740) CRYSTAL LEGAL ASSOCIATES  
(814) MZ, TZ, UG



(111) AP/M/2024/006520  
(151) 31.07.2025  
(220) 13.05.2024  
(511) Int. Cl. 1: TZ, UG  
(731) ZHEJIANG JIUERJIU CHEMICALS CO.,LTD.  
(740) CRYSTAL LEGAL ASSOCIATES  
(814) TZ, UG



## Marks Registered (Contd.)

(111) AP/M/2024/006525

(151) 18.07.2025

(220) 15.05.2024

(511) Int. Cl. 36: ZW

(731) KUVHA SANCHEZ (PVT) LTD T/A  
KUVACASH(740) KUVHA SANCHEZ (PVT) LTD T/A  
KUVACASH

(814) ZW

(540)



(111) AP/M/2024/006526

(151) 18.07.2025

(220) 15.05.2024

(511) Int. Cl. 36: ZW

(731) KUVHA SANCHEZ (PVT) LTD T/A  
KUVACASH(740) KUVHA SANCHEZ (PVT) LTD T/A  
KUVACASH

(814) ZW

(540)



(111) AP/M/2024/006533

(151) 31.07.2025

(220) 22.05.2024

(511) Int. Cl. 9: LR, ZW

(731) GUOFU Zheng

(740) CRYSTAL LEGAL ASSOCIATES

(814) LR, ZW

(540) **AIFIFA**

(111) AP/M/2024/006536

(151) 29.07.2025

(220) 24.05.2024

(511) Int. Cl. 39: BW, MZ, ZW

(731) TRANSWORLD CARGO  
(PROPRIETARY) LIMITED

(740) Cronjé &amp; Co.

(814) BW, MZ, ZW

(540)



(111) AP/M/2024/006539

(151) 29.07.2025

(220) 27.05.2024

(511) Int. Cl. 30: BW, CV, GM, LR, LS, MW,  
MZ, NA, ST, SZ, TZ, UG, ZW

(731) RAVI FOODS PVT LTD

(740) Cronjé &amp; Co.

(814) BW, CV, GM, LR, LS, MW, MZ, NA,  
ST, SZ, TZ, UG, ZW

(540)



(111) AP/M/2024/006552

(151) 31.07.2025

(220) 30.05.2024

(511) Int. Cl. 34: ZW

(731) GOLD DRIVEN GROUP LIMITED

(740) FERRAO LAW CHAMBERS

(814) ZW

(540)



(111) AP/M/2024/006567

(151) 10.07.2025

(220) 10.06.2024

(511) Int. Cl. 9 and 42: BW, CV, GM, LR,  
LS, MW, MZ, NA, ST, SZ, TZ, UG, ZW

(731) EJADA SYSTEMS COMPANY LIMITED

(740) FISHER, CORMACK &amp; BOTHA

(814) BW, CV, GM, LR, LS, MW, MZ, NA,  
ST, SZ, TZ, UG, ZW

(540)



(111) AP/M/2024/006568

(151) 31.07.2025

(220) 10.06.2024

(511) Int. Cl. 5: BW, CV, GM, LR, LS, MW,  
MZ, NA, ST, SZ, TZ, UG, ZW

(731) F. HOFFMANN-LA ROCHE AG

(740) FISHER, CORMACK &amp; BOTHA

(814) BW, CV, GM, LR, LS, MW, MZ, NA,  
ST, SZ, TZ, UG, ZW(540) **UTEMPEO**

(111) AP/M/2024/006583

(151) 31.07.2025

(220) 14.06.2024

(511) Int. Cl. 1: BW, CV, GM, LR, LS, MW,  
MZ, NA, ST, SZ, TZ, UG, ZW(731) ARAB FERTILIZERS & CHEMICALS  
INDUSTRIES CO.

(740) SAMURIWO ATTORNEYS

(814) BW, CV, GM, LR, LS, MW, MZ, NA,  
ST, SZ, TZ, UG, ZW(540) **KEMAPCO** **كيماپكو**

(111) AP/M/2024/006589

(151) 24.07.2025

(220) 14.06.2024

(511) Int. Cl. 11, 17 and 19: ZW

(731) LIGHTGROVE INVESTMENTS PVT  
LTD

(740) Patel Mohammed Hanif

(814) ZW

(540)



(111) AP/M/2024/006594

(151) 31.07.2025

(220) 21.06.2024

(511) Int. Cl. 3: BW, CV, GM, LR, LS, MW,  
MZ, NA, ST, SZ, TZ, UG, ZW

(731) AMINA LIMITED

(740) HUSSEIN &amp; Co.

(814) BW, CV, GM, LR, LS, MW, MZ, NA,  
ST, SZ, TZ, UG, ZW(540) **EPICOOOL**

(111) AP/M/2024/006595

(151) 31.07.2025

(220) 21.06.2024

(511) Int. Cl. 5: BW, CV, GM, LR, LS, MW,  
MZ, NA, ST, SZ, TZ, UG, ZW

(731) AMINA LIMITED

(740) HUSSEIN &amp; Co.

(814) BW, CV, GM, LR, LS, MW, MZ, NA,  
ST, SZ, TZ, UG, ZW(540) **SONACARE**

**Marks  
Registered  
(Contd.)**

(111) AP/M/2024/006597  
 (151) 31.07.2025  
 (220) 24.06.2024  
 (511) Int. Cl. 30: TZ  
 (731) TRADE KINGS LIMITED  
 (740) TRADE KINGS ZIMBABWE (PVT.) LIMITED  
 (814) TZ

(540) **BON JOY**



(111) AP/M/2024/006599  
 (151) 31.07.2025  
 (220) 25.06.2024  
 (511) Int. Cl. 3 and 5: ZW  
 (731) HYDRA QUEST LTD  
 (740) SAMURIWO ATTORNEYS  
 (814) ZW

(540)



(111) AP/M/2024/006615  
 (151) 31.07.2025  
 (220) 03.07.2024  
 (511) Int. Cl. 30: MW, MZ, TZ, ZW  
 (731) TRADE KINGS LIMITED  
 (740) TRADE KINGS ZIMBABWE (PVT.) LIMITED  
 (814) MW, MZ, TZ, ZW

(540)



(111) AP/M/2024/006623  
 (151) 31.07.2025  
 (220) 08.07.2024  
 (511) Int. Cl. 2: ZW  
 (731) ZHANG Kun  
 (740) NGWENYA Mthokozisi

(814) ZW

(540) **Qetesh**



(111) AP/M/2024/006639  
 (151) 31.07.2025  
 (220) 13.07.2024  
 (511) Int. Cl. 32: MW, MZ  
 (731) BIGTREE BEVERAGES LIMITED  
 (740) TRADE KINGS ZIMBABWE (PVT.) LIMITED  
 (814) MW, MZ

(540) **FRULEITE**



(111) AP/M/2024/006640  
 (151) 31.07.2025  
 (220) 13.07.2024  
 (511) Int. Cl. 32: MW, MZ  
 (731) BIGTREE BEVERAGES LIMITED  
 (740) TRADE KINGS ZIMBABWE (PVT.) LIMITED  
 (814) MW, MZ

(540) **FRUTLAIT**



(111) AP/M/2024/006642  
 (151) 31.07.2025  
 (220) 15.07.2024  
 (511) Int. Cl. 30: BW, CV, GM, LR, LS, MW, MZ, NA, ST, SZ, TZ, UG, ZW  
 (731) DIP N DIP INC.  
 (740) SAMURIWO ATTORNEYS  
 (814) BW, CV, GM, LR, LS, MW, MZ, NA, ST, SZ, TZ, UG, ZW

(540)



(111) AP/M/2024/006643  
 (151) 31.07.2025  
 (220) 15.07.2024  
 (511) Int. Cl. 32: MW, ZW  
 (731) BIGTREE BEVERAGES LIMITED  
 (740) TRADE KINGS ZIMBABWE (PVT.) LIMITED  
 (814) MW, ZW

(540) **RED COLA**



(111) AP/M/2024/006646  
 (151) 31.07.2025

(220) 16.07.2024

(511) Int. Cl. 3, 7, 8 and 35: ZW  
 (731) SHENZHEN WELLDON ABRASIVES CO., LTD  
 (740) NGWENYA Mthokozisi  
 (814) ZW

(540)



## Marks Renewed

Registration No.	Date Fee Paid	Valid Until	Anniversary
AP/M/2014/001977	09.07.2025	02.04.2034	10th yr
AP/M/2014/001978	09.07.2025	02.04.2034	10th yr
AP/M/2014/001981	09.07.2025	07.04.2034	10th yr
AP/M/2014/001982	09.07.2025	07.04.2034	10th yr
AP/M/2014/001984	09.07.2025	07.04.2034	10th yr
AP/M/2014/001985	09.07.2025	07.04.2034	10th yr
AP/M/2014/001986	09.07.2025	07.04.2034	10th yr
AP/M/2014/001987	09.07.2025	07.04.2034	10th yr
AP/M/2014/001989	09.07.2025	07.04.2034	10th yr
AP/M/2014/001990	09.07.2025	07.04.2034	10th yr
AP/M/2014/001991	09.07.2025	07.04.2034	10th yr
AP/M/2014/002177	17.07.2025	01.10.2034	10th yr
AP/M/2014/002205	22.07.2025	28.10.2034	10th yr
AP/M/2015/002296	28.07.2025	02.02.2035	10th yr
AP/M/2015/002296	28.07.2025	02.02.2035	1st yr
AP/M/2015/002312	10.06.2025	19.02.2045	20th yr
AP/M/2015/002381	10.06.2025	27.04.2045	20th yr
AP/M/2015/002390	11.07.2025	18.05.2035	10th yr
AP/M/2015/002390	11.07.2025	18.05.2035	1st yr
AP/M/2015/002411	25.06.2025	30.06.2035	10th yr
AP/M/2015/002413	10.07.2025	07.07.2035	10th yr
AP/M/2015/002433	17.07.2025	17.07.2035	10th yr
AP/M/2015/002453	18.07.2025	31.07.2035	10th yr
AP/M/2015/002455	18.07.2025	06.08.2035	10th yr

# PATENTS

## Patent Applications Filed

(21) AP/P/2025/016619  
 (22) 11.09.2020  
 (23) 01.07.2025  
 (31) 62/898,679  
     (32) 11.09.2019 (33) US  
 (51) **C07H 19/173 (2006.01)**  
**C07H 19/16 (2006.01)**  
**A61K 31/70 (2006.01)**  
 (54) ANTIVIRAL PRODRUGS AND FORMULATIONS THEREOF  
 (71) THE SCRIPPS RESEARCH INSTITUTE  
 (72) JOSEPH Sean Barry, ELIASSEN Andres Mikal, GUPTA Anil Kumar, et al  
 (74) B. W. KAHARI LEGAL PRACTITIONERS  
 (84) BW, GH, GM, KE, LR, LS, MW, MZ, NA, RW, SD, SL, ST, SZ, TZ, UG, ZM, ZW  
 (96) 11.09.2020 AP/P/2025/016619



(21) AP/P/2025/016620  
 (22) 02.07.2025  
 (23) 02.07.2025  
 (31) 24186914.8  
     (32) 05.07.2024 (33) EP  
 (51) **H04N 19/13 (2014.01)**  
**H04N 19/50 (2014.01)**  
**H04N 19/91 (2014.01)**  
 (54) TRUSTWORTHINESS OF A VIDEO DATA STREAM  
 (71) FRAUNHOFER-GESELLSCHAFT ZUR FÖRDERUNG DER ANGEWANDTEN FORSCHUNG E.V.  
 (72) WIEGAND Thomas, MARPE Detlev, SCHIERL Thomas, et al  
 (74) Galloway & Co (NA)  
 (84) KE, ZW  
 (96) 02.07.2025 AP/P/2025/016620



(21) AP/P/2025/016621  
 (22) 01.08.2023  
 (23) 02.07.2025  
 (51) **F01B 1/02 (2006.01)**  
**F03B 17/02 (2006.01)**  
**F03B 17/00 (2006.01)**  
**F01B 25/02 (2006.01)**  
 (54) ENGINE THAT CONVERTS THE POTENTIAL ENERGY OF A LIQUID FLUID STORED IN ITS UPPER TANK TO KINETIC ENERGY  
 (74) Mwongela Mwendwa  
 (75) MWONGELA Mwendwa  
 (84) BW, CV, GH, GM, LR, LS, MW, MZ, NA, RW, SC, SD, SL, ST, SZ, TZ, UG, ZM, ZW  
 (96) 01.08.2023 AP/P/2025/016621



(21) AP/P/2025/016622  
 (22) 24.11.2023  
 (23) 02.07.2025  
 (31) 202211537702.4  
     (32) 06.06.2024 (33) CN  
 (51) **A61K 39/275 (2006.01)**  
**A61K 39/39 (2006.01)**  
**A61P 31/20 (2006.01)**  
**C12N 15/85 (2006.01)**  
**C12N 5/10 (2006.01)**  
**C07K 14/065 (2006.01)**  
**C12N 15/62 (2006.01)**  
**C12N 15/39 (2006.01)**  
**C07K 19/00 (2006.01)**  
 (54) MULTI-ANTIGEN CHIMERIC VACCINE AGAINST POXVIRUS AND USE THEREOF  
 (71) INSTITUTE OF MICROBIOLOGY, CHINESE ACADEMY OF SCIENCES  
 (72) MA Renyi, QI Jianxun, QU Xiao, et al  
 (74) NGWENYA Mthokozisi  
 (84) BW, CV, GH, GM, KE, LR, LS, MW, MZ, NA, SC, SD, SL, ST, SZ, TZ, ZM, ZW  
 (86) 24.11.2023 PCT/CN2023/134141  
 (96) 24.11.2023 AP/P/2025/016622



(21) AP/P/2025/016624  
 (22) 19.12.2023  
 (23) 03.07.2025  
 (31) 22386097.4  
     (32) 19.12.2022 (33) EP  
 (51) **A01G 22/00 (2018.01)**  
**A01G 17/00 (2006.01)**  
 (54) TEA AGRICULTURE SYSTEMS  
 (71) EKATERA RESEARCH AND DEVELOPMENT UK LIMITED  
 (72) REDFERN Sally, DE SILVA Jacquie, WAINE Toby, et al  
 (74) SPOOR.FISHER  
 (84) KE, RW, TZ  
 (86) 19.12.2023 PCT/EP2023/025545  
 (96) 19.12.2023 AP/P/2025/016624



(21) AP/P/2025/016625  
 (22) 26.12.2023  
 (23) 03.07.2025  
 (31) 1020230256260  
     (32) 06.12.2023 (33) BR  
 (31) 1020230002650  
     (32) 23.01.2023 (33) BR  
 (51) **C22B 1/243 (2006.01)**  
**C22B 1/24 (2006.01)**  
 (54) PROCESS FOR PRODUCTION OF IRON ORE AGGLOMERATE FOR USE IN DIRECT REDUCTION REACTORS AND THE AGGLOMERATED PRODUCT  
 (71) VALE S.A.  
 (72) PIMENTA Felipe Viana, PARREIRA Fabricio Vilela, DUTRA Flávio de Castro, et al  
 (74) ADAMS AND ADAMS MOZAMBIQUE

(84) LR, SL  
 (96) 26.12.2023 AP/P/2025/016625



(21) AP/P/2025/016626  
 (22) 05.12.2023  
 (23) 04.07.2025  
 (31) 63/497,847  
     (32) 24.04.2023 (33) US  
 (31) 63/386,263  
     (32) 06.12.2022 (33) US  
 (51) **A61K 31/52 (2006.01)**  
**A61P 35/00 (2006.01)**  
**C07D 473/26 (2006.01)**  
**C07D 471/04 (2006.01)**  
**C07D 235/18 (2006.01)**  
 (54) POLQ INHIBITORS  
 (71) ASTRAZENECA AB  
 (72) JONES Helen Elizabeth, FERRER-CABRERA Sofia, SHIELDS Jason, et al  
 (74) ADAMS AND ADAMS MOZAMBIQUE  
 (84) GH, KE  
 (86) 05.12.2023 PCT/IB2023/062262  
 (96) 05.12.2023 AP/P/2025/016626



(21) AP/P/2025/016627  
 (22) 29.11.2023  
 (23) 04.07.2025  
 (31) P202231072  
     (32) 15.12.2022 (33) ES  
 (51) **C12N 1/20 (2006.01)**  
**C12R 1/01 (2006.01)**  
 (54) PERIBACILLUS ARACENENSIS BBB004 STIMULATOR OF PLANT ADAPTIVE METABOLISM AGAINST WATER STRESS, ENHANCER OF PLANT NUTRITION AND POLYPHENOL CONTENT  
 (71) BIOBAB R&D, S.L.  
 (72) LUCAS GARCÍA Jose Antonio, GARCÍA-VILLARACO VELASCO Ana, GUTIERREZ MAÑERO Francisco Javier, et al  
 (74) Cronjé & Co.  
 (84) KE  
 (86) 29.11.2023 PCT/ES2023/070709  
 (96) 29.11.2023 AP/P/2025/016627



(21) AP/P/2025/016628  
 (22) 11.01.2024  
 (23) 07.07.2025  
 (31) 102023000000357  
     (32) 12.01.2023 (33) IT  
 (51) **E01F 7/04 (2006.01)**  
 (54) PROTECTION NETTING FOR CIVIL WORKS WITH HIGHLY RESISTANT METAL WIRES WITH A PROTECTIVE COATING



## Patent Applications Filed (Contd.)

(71) OFFICINE MACCAFERRI S.P.A.  
(72) GAGLIARDI Antoine  
(74) COGHLAN, WELSH & GUEST  
(84) BW, GH, GM, KE, LR, LS, MW, MZ, NA,  
RW, SD, SL, TZ, UG, ZM, ZW  
(86) 11.01.2024 PCT/IB2024/050286  
(96) 11.01.2024 AP/P/2025/016628

● ●

(21) AP/P/2025/016629  
(22) 18.12.2023  
(23) 07.07.2025  
(31) 18/543,198  
(32) 18.12.2023 (33) US  
(31) 63/476,880  
(32) 22.12.2022 (33) US  
(51) **C09G 1/04 (2006.01)**  
(54) PARAFFIN WAX DISPERSANT  
(71) CHAMPIONX LLC  
(72) NGUYEN Duy T, IVERSON Scott  
Kenneth and YUAN Shu Jun

(74) SPOOR.FISHER  
(84) GH, UG  
(86) 18.12.2023 PCT/US2023/084555  
(96) 18.12.2023 AP/P/2025/016629

● ●

(21) AP/P/2025/016630  
(22) 09.01.2024  
(23) 07.07.2025  
(31) 2319255.2  
(32) 15.12.2023 (33) GB  
(31) 2300277.7  
(32) 09.01.2023 (33) GB  
(31) 2317371.9  
(32) 13.11.2023 (33) GB  
(51) **A61K 39/00 (2006.01)**  
**C07K 16/18 (2006.01)**  
**A61P 25/28 (2006.01)**  
(54) ANTI-UNC5C ANTIBODIES  
(71) ELI LILLY AND COMPANY  
(72) HAWTHORNE William James,  
PEDIADITAKIS Iosif, KOLASINSKA-  
ZWIERZ Paulina Maria, et al  
(74) ADAMS AND ADAMS MOZAMBIQUE  
(84) BW, GH, KE, NA  
(96) 09.01.2024 AP/P/2025/016630

● ●

(21) AP/P/2025/016631  
(22) 18.12.2023  
(23) 08.07.2025  
(31) 63/433,399  
(32) 16.12.2022 (33) US  
(51) **F23J 15/02 (2006.01)**  
**F23J 15/00 (2006.01)**  
(54) SYSTEMS FOR EXHAUST POLLUTION  
MITIGATION  
(71) ECC TEC MSJ INCORPORATED  
(72) AKYILDIZ Saban

(74) ROLAND INTELLECTUAL PROPERTY  
CONSULTANTS  
(84) BW, CV, GH, GM, KE, LR, LS, MW, MZ,  
NA, RW, SC, SD, SL, ST, SZ, TZ, UG,  
ZM, ZW  
(86) 18.12.2023 PCT/US2023/084609  
(96) 18.12.2023 AP/P/2025/016631

● ●

(21) AP/P/2025/016632  
(22) 05.05.2023  
(23) 08.07.2025  
(31) 18/081,704  
(32) 15.12.2022 (33) US  
(51) **B65D 6/14 (2006.01)**  
**HOLM 50/244 (2021.01)**  
**B65D 85/88 (2006.01)**  
(54) MOVABLE CABINET AND ENERGY  
STORAGE APPARATUS  
(71) TCC (HANGZHOU) NEW ENERGY  
COMPANY LIMITED and TCC  
ENERGY STORAGE TECHNOLOGY  
CORPORATION  
(72) LI Jong-Peir and CHANG An-Ping  
(74) SPOOR.FISHER  
(84) CV  
(86) 05.05.2023 PCT/CN2023/092249  
(96) 05.05.2023 AP/P/2025/016632

● ●

(21) AP/P/2025/016633  
(22) 15.01.2024  
(23) 14.07.2025  
(31) 63/450,971  
(32) 09.07.2023 (33) US  
(31) 63/480,016  
(32) 16.01.2023 (33) US  
(51) **A61K 47/10 (2017.01)**  
**A61K 51/06 (2006.01)**  
**G21G 1/00 (2006.01)**  
**A61K 51/12 (2006.01)**  
**A61K 47/69 (2017.01)**  
**A61N 5/10 (2006.01)**  
**A61K 47/36 (2006.01)**  
**A61N 5/00 (2006.01)**  
**A61K 51/02 (2006.01)**  
**A61P 35/00 (2006.01)**

(54) GEL LOADED WITH ALPHA-EMITTER  
RADIIONUCLIDE  
(71) ALPHA TAU MEDICAL LTD.  
(72) SEGAL Ronen, ARAZI Lior, KELSON  
Itzhak, et al  
(74) Cronjé & Co.  
(84) BW, CV, GH, GM, KE, LR, LS, MW, MZ,  
NA, RW, SC, SD, SL, ST, SZ, TZ, UG,  
ZM, ZW  
(86) 15.01.2024 PCT/IB2024/050380  
(96) 15.01.2024 AP/P/2025/016633

● ●

(21) AP/P/2025/016634  
(22) 06.05.2024  
(23) 08.07.2025  
(31) 202311455118.9  
(32) 03.11.2023 (33) CN  
(51) **A01P 13/00 (2006.01)**  
**C07D 413/10 (2006.01)**  
**A01N 43/80 (2006.01)**

(54) TOPRAMEZONE DERIVATIVE AND  
USE THEREOF  
(71) LV Zhitao, SHANDONG  
CHENGCHUANG BLUE SEA  
PHARMACEUTICAL TECHNOLOGY  
CO., LTD. and SHANDONG DEHAO  
CHEMICAL CO., LTD.  
(72) WANG Huijun, ZHANG Cailing, WU  
Wenpeng, et al  
(74) NGWENYA Mthokozisi  
(75) LV Zhitao  
(84) BW, CV, GH, GM, KE, LR, LS, MW, MZ,  
NA, RW, SC, SD, SL, ST, SZ, TZ, UG,  
ZM, ZW  
(86) 06.05.2024 PCT/CN2024/091133  
(96) 06.05.2024 AP/P/2025/016634

● ●

(21) AP/P/2025/016635  
(22) 12.01.2024  
(23) 09.07.2025  
(31) 63/479,757  
(32) 13.01.2023 (33) US  
(51) **C12N 15/113 (2010.01)**  
**A61K 31/713 (2006.01)**  
(54) THERAPEUTIC OLIGONUCLEOTIDE-  
CONTAINING PHARMACEUTICAL  
COMPOSITIONS AND DOSING  
REGIMENS USING THE SAME  
(71) ELI LILLY AND COMPANY  
(72) NI Wei, MA Xiaosu, KREGG John  
Henry, et al  
(74) ADAMS AND ADAMS MOZAMBIQUE  
(84) BW, GH, KE, NA  
(86) 12.01.2024 PCT/US2024/011378  
(96) 12.01.2024 AP/P/2025/016635

● ●

(21) AP/P/2025/016636  
(22) 12.07.2023  
(23) 09.07.2025  
(31) 202310086433.2  
(32) 18.01.2023 (33) CN  
(51) **A61P 31/20 (2006.01)**  
**C12N 15/39 (2006.01)**  
**C12N 15/62 (2006.01)**  
**A61P 31/12 (2006.01)**  
**C07K 19/00 (2006.01)**  
**A61K 39/275 (2006.01)**  
**C07K 14/065 (2006.01)**  
(54) RECOMBINANT CHIMERIC ANTIGEN  
FOR POXVIRUS, SUBUNIT VACCINE  
COMPRISING SAME AND USE  
THEREOF  
(71) BEIHANG UNIVERSITY, SHANXI  
ACADEMY OF ADVANCED RESEARCH  
AND INNOVATION, INSTITUTE OF  
MICROBIOLOGY, CHINESE ACADEMY  
OF SCIENCES, et al  
(72) CUI Qingwei, LIU Zhida, WANG Qihui,  
et al  
(74) ROLAND INTELLECTUAL PROPERTY  
CONSULTANTS



## Patent Applications Filed (Contd.)

- (84) BW, CV, GH, GM, KE, LR, LS, MW, MZ, NA, RW, SC, SD, SL, ST, SZ, TZ, UG, ZM, ZW
- (86) 12.07.2023 PCT/CN2023/107061  
(96) 12.07.2023 AP/P/2025/016636
- ●
- (21) AP/P/2025/016637  
(22) 11.01.2024  
(23) 14.07.2025  
(31) 63/438,543  
(32) 12.01.2023 (33) US
- (51) **A61K 31/4355 (2006.01)**  
**A61P 17/00 (2006.01)**  
**A61P 35/00 (2006.01)**  
**A61K 9/00 (2006.01)**
- (54) TREATMENT AND PREVENTION OF BASAL CELL CARCINOMA WITH TOPICAL COMPOSITION COMPRISING PATIDEGIB
- (71) SOL-GEL TECHNOLOGIES LTD.  
(72) TANG Jean, EPSTEIN Ervin, TOLEDANO Ofer, et al  
(74) ADAMS AND ADAMS MOZAMBIQUE
- (84) BW, CV, GH, GM, KE, LR, LS, MW, MZ, NA, RW, SC, SD, SL, ST, SZ, TZ, UG, ZM, ZW
- (86) 11.01.2024 PCT/IL2024/050047  
(96) 11.01.2024 AP/P/2025/016637
- ●
- (21) AP/P/2025/016638  
(22) 22.12.2023  
(23) 14.07.2025  
(31) 2022/13909  
(32) 22.12.2022 (33) ZA
- (51) **B03C 1/22 (2006.01)**
- (54) APPARATUS AND METHOD FOR PERFORMING MAGNETIC SEPARATION
- (71) MARTIN AND ROBSON  
(72) LE ROUX Charles Roberts  
(74) ROLAND INTELLECTUAL PROPERTY CONSULTANTS
- (84) BW, CV, GH, GM, KE, LR, LS, MW, MZ, NA, RW, SC, SD, SL, ST, SZ, TZ, UG, ZM, ZW
- (86) 22.12.2023 PCT/ZA2023/050076  
(96) 22.12.2023 AP/P/2025/016638
- ●
- (21) AP/P/2025/016639  
(22) 15.12.2023  
(23) 14.07.2025  
(31) 63/387,734  
(32) 16.12.2022 (33) US
- (51) **C07D 473/16 (2006.01)**  
**A61K 31/52 (2006.01)**  
**C07D 473/16 (2006.01)**  
**A61P 35/00 (2006.01)**
- (54) 2,6,9-TRISUBSTITUTED PURINES
- (71) ASTRAZENECA AB  
(72) SHEPPECK James, TELMESANI Reem, SONG Kun, et al  
(74) ADAMS AND ADAMS MOZAMBIQUE
- (84) GH, KE  
(86) 15.12.2023 PCT/IB2023/062789  
(96) 15.12.2023 AP/P/2025/016639
- ●
- (21) AP/P/2025/016640  
(22) 14.12.2023  
(23) 14.07.2025  
(31) 63/496,159  
(32) 14.04.2023 (33) US
- (31) 63/478,640  
(32) 05.01.2023 (33) US
- (51) **C07K 16/30 (2006.01)**  
**A61P 35/00 (2006.01)**  
**C07K 19/00 (2006.01)**  
**C07K 16/28 (2006.01)**  
**A61K 39/395 (2006.01)**
- (54) TROP2 TARGETING TRISPECIFIC PROTEIN FOR TREATMENT OF CANCER
- (71) HARPOON THERAPEUTICS, INC.  
(72) AUSTIN Richard J, WRIGHT Kevin J, LIN Shuoyen Jack, et al  
(74) HONEY & BLANCKENBERG
- (84) BW, GH, KE, NA, SC  
(86) 14.12.2023 PCT/US2023/083985  
(96) 14.12.2023 AP/P/2025/016640
- ●
- (21) AP/P/2025/016641  
(22) 16.01.2024  
(23) 15.07.2025  
(31) 63/480,113  
(32) 17.01.2023 (33) US
- (51) **A61K 47/86 (2017.01)**
- (54) NOVEL LINKERS FOR SUSTAINED DELIVERY OF THERAPEUTICS
- (71) ELI LILLY AND COMPANY  
(72) WANG Yan, STOKELL David John, MUPPIDI Avinash, et al  
(74) ADAMS AND ADAMS MOZAMBIQUE
- (84) BW, GH, KE, NA  
(86) 16.01.2024 PCT/US2024/011615  
(96) 16.01.2024 AP/P/2025/016641
- ●
- (21) AP/P/2025/016642  
(22) 13.12.2023  
(23) 15.07.2025  
(31) 2219220.7  
(32) 20.12.2022 (33) GB
- (51) **G01N 21/87 (2006.01)**
- (54) GEMSTONE HOLDER
- (71) DE BEERS UK LTD  
(72) NIKIFOROV Ivan, FELIX James, BODHINAYAKE Sud, et al  
(74) ADAMS AND ADAMS MOZAMBIQUE
- (84) BW, NA  
(86) 13.12.2023 PCT/EP2023/085562  
(96) 13.12.2023 AP/P/2025/016642
- ●
- (21) AP/P/2025/016643  
(22) 13.12.2023  
(23) 15.07.2025  
(31) 2219219.9  
(32) 20.12.2022 (33) GB
- (51) **G01N 21/23 (2006.01)**  
**G01N 21/23 (2006.01)**  
**G01N 21/88 (2006.01)**
- (54) OPTICAL CHARACTERISATION OF A GEMSTONE
- (71) DE BEERS UK LTD  
(72) NIKIFOROV Ivan, LANIGAN Peter, POWELL Graham, et al  
(74) ADAMS AND ADAMS MOZAMBIQUE
- (84) BW, NA  
(86) 13.12.2023 PCT/EP2023/085549  
(96) 13.12.2023 AP/P/2025/016643
- ●
- (21) AP/P/2025/016644  
(22) 26.01.2024  
(23) 15.07.2025  
(31) 23208345.1  
(32) 07.11.2023 (33) EP
- (31) 23166392.3  
(32) 03.04.2023 (33) EP
- (31) 202311005537  
(32) 27.01.2023 (33) IN
- (51) **C07D 401/06 (2006.01)**  
**A01N 43/82 (2006.01)**  
**C07D 401/14 (2006.01)**  
**C07D 401/04 (2006.01)**  
**A01N 43/80 (2006.01)**  
**C07D 211//84 (2006.01)**
- (54) MICROBIOCIDAL PYRAZOLE DERIVATIVES
- (71) SYNGENTA CROP PROTECTION AG  
(72) MAHAJAN Atul, SCARBOROUGH Christopher Charles and EDMUNDS Andrew  
(74) ADAMS AND ADAMS MOZAMBIQUE
- (84) GH, KE  
(86) 26.01.2024 PCT/EP2024/051942  
(96) 26.01.2024 AP/P/2025/016644
- ●
- (21) AP/P/2025/016645  
(22) 26.01.2024  
(23) 15.07.2025  
(31) 63/607595  
(32) 08.12.2023 (33) US
- (31) 63/482133  
(32) 30.01.2023 (33) US
- (51) **C07H 19/14 (2006.01)**  
**A61K 31/7052 (2006.01)**
- (54) PRODRUGS OF 4'-SUBSTITUTED NUCLEOSIDE REVERSE TRANSCRIPTASE INHIBITORS

## Patent Applications Filed (Contd.)

- (71) MERCK SHARP & DOHME LLC  
(72) GROBLER Jay A, RAHEEM Izzat T, LAYTON Mark Eric, et al  
(74) HONEY & BLANCKENBERG  
(84) BW, GH, KE, NA, SC  
(86) 26.01.2024 PCT/US2024/013021  
(96) 26.01.2024 AP/P/2025/016645
- ●
- (21) AP/P/2025/016646  
(22) 08.01.2024  
(23) 15.07.2025  
(31) 63/479,119  
(32) 09.01.2023 (33) US  
(51) **B01D 9/00 (2006.01)**  
**B01D 11/02 (2006.01)**  
(54) PROCESS FOR PURIFICATION OF CHEMICAL COMPONENTS FROM PLANT MATTER  
(71) KB CRASH CREATIONS LLC  
(72) DAWYOT John, BENDISTIS Wayne and KILHEENEY Cory  
(74) SPOOR.FISHER  
(84) GH, TZ, UG  
(86) 08.01.2024 PCT/US2024/010736  
(96) 08.01.2024 AP/P/2025/016646
- ●
- (21) AP/P/2025/016647  
(22) 15.02.2024  
(23) 16.07.2025  
(31) 63/485,931  
(32) 20.02.2023 (33) US  
(51) **A01P 21/00 (2006.01)**  
**A01N 33.04 (2006.01)**  
**A01N 37/04 (2006.01)**  
**A01G 7/06 (2024.01)**  
(54) METHODS AND COMPOSITIONS FOR INCREASING TOLERANCE TO ABIOTIC STRESS IN PLANTS  
(71) CROP MICROCLIMATE MANAGEMENT INC.  
(72) KUPATT Charles Christian  
(74) ROLAND INTELLECTUAL PROPERTY CONSULTANTS  
(84) BW, CV, GH, GM, KE, LR, LS, MW, MZ, NA, RW, SC, SD, SL, ST, SZ, TZ, UG, ZM, ZW  
(86) 15.02.2024 PCT/US2024/015899  
(96) 15.02.2024 AP/P/2025/016647
- ●
- (21) AP/P/2025/016648  
(22) 22.12.2023  
(23) 16.07.2025  
(31) 63/520,524  
(32) 18.08.2023 (33) US  
(31) 63/518,057  
(32) 07.08.2023 (33) US

- (31) 63/516,732  
(32) 31.07.2023 (33) US  
(31) 63/507,125  
(32) 09.06.2023 (33) US  
(31) 63/485,108  
(32) 15.02.2023 (33) US  
(31) 63/476,830  
(32) 22.12.2022 (33) US  
(51) **A61K 47/42 (2017.01)**  
**A61K 38/00 (2006.01)**  
**A61M 5/20 (2006.01)**  
**C12N 9/24 (2006.01)**  
**A61K 9/00 (2006.01)**  
**A61K 9/08 (2006.01)**  
(54) HYALURONIDASE ENZYME FORMULATIONS FOR HIGH VOLUME ADMINISTRATION  
(71) HALOZYME, INC.  
(72) TRAVANTY Mike, SWANSON Kevin, BEACHER Scott, et al  
(74) ENSAfrica Namibia  
(84) BW, SD, TZ  
(86) 22.12.2023 PCT/US2023/085807  
(96) 22.12.2023 AP/P/2025/016648
- ●
- (21) AP/P/2025/016649  
(22) 17.04.2023  
(23) 16.07.2025  
(31) KE/U/2023/002004  
(32) 13.01.2023 (33) KE  
(31) KE/U/2023/002003  
(32) 13.01.2023 (33) KE  
(51) **F25D 11/00 (2006.01)**  
(54) PORTABLE SOLAR POWERED VACCINE REFRIGERATOR  
(71) DROP ACCESS LIMITED  
(72) MULATYA James and MAGERO Norah  
(74) OTSWONG'O Omukubi Fredrick  
(84) BW, CV, GH, GM, LR, LS, MW, MZ, NA, RW, SC, SD, SL, ST, SZ, TZ, UG, ZM, ZW  
(86) 17.04.2023 PCT/KE2023/050006  
(96) 17.04.2023 AP/P/2025/016649
- ●
- (21) AP/P/2025/016650  
(22) 26.12.2023  
(23) 17.07.2025  
(31) 63/477,306  
(32) 27.12.2022 (33) US  
(51) **G01N 33/50 (2006.01)**  
**C12N 1/21 (2006.01)**  
**C12N 15/11 (2006.01)**  
**C05F 11/08 (2006.01)**  
**C07K 14/32 (2006.01)**  
**A01N 63/20 (2020.01)**  
**A01H 3/00 (2006.01)**  
(54) COMPOSITIONS AND METHODS FOR NITROGEN FIXATION CLUSTER REGULATION  
(71) BIOCONSORTIA, INC.  
(72) WILLIAMS Thomas, MALIN John, CURTIS Damian, et al  
(74) SPOOR.FISHER

- (84) BW, CV, GH, GM, KE, LR, LS, MW, MZ, NA, RW, SC, SD, SL, ST, SZ, TZ, UG, ZM, ZW  
(96) 26.12.2023 AP/P/2025/016650
- ●
- (21) AP/P/2025/016651  
(22) 15.02.2024  
(23) 17.07.2025  
(31) 2023-024538  
(32) 20.02.2023 (33) JP  
(51) **G06Q 20/32 (2012.01)**  
(54) MONEY TRANSACTION SYSTEM, INFORMATION TERMINAL, COMPUTER PROGRAM, AND MONEY TRANSACTION METHOD  
(71) VARIETY M-1 INC.  
(72) MITAKE Toshiaki  
(74) SPOOR.FISHER  
(84) GH  
(96) 15.02.2024 AP/P/2025/016651
- ●
- (21) AP/P/2025/016652  
(22) 27.02.2024  
(23) 17.07.2025  
(31) 23159067.0  
(32) 28.02.2023 (33) EP  
(51) **A61K 31/519 (2006.01)**  
**A61P 11/00 (2006.01)**  
**C07D 453/04 (2006.01)**  
(54) [1,3]THIAZOLO[4,5-D]-PYRIMIDIN-7-ONES AS INHIBITORS OF NOX4  
(71) BOEHRINGER INGELHEIM INTERNATIONAL GMBH  
(72) WILDERMUTH Raphael, WIEDENMAYER Dieter, KUTTRUFF Christian Andreas, et al  
(74) Cronjé & Co.  
(84) GH, KE  
(86) 27.02.2024 PCT/EP2024/054867  
(96) 27.02.2024 AP/P/2025/016652
- ●
- (21) AP/P/2025/016653  
(22) 28.12.2023  
(23) 21.07.2025  
(31) 2022-212878  
(32) 31.12.2022 (33) JP  
(51) **F16B 39/18 (2006.01)**  
**F16B 39/30 (2006.01)**  
(54) SCREW STRUCTURE  
(71) HARDLOCK INDUSTRY CO., LTD.  
(72) WAKABAYASHI Katsuhiko (deceased)  
(74) SPOOR.FISHER  
(84) MZ  
(86) 22.12.2023 PCT/JP2023/047272  
(96) 28.12.2023 AP/P/2025/016653
- ●



## Patent Applications Filed (Contd.)

- (21) AP/P/2025/016654  
(22) 18.07.2025  
(23) 18.07.2025  
(51) **G06Q 50/02 (2024.01)**  
**G06Q 10/06 (2024.01)**  
**G06Q 10/0006 (2024.01)**  
(54) INTEGRATED EXPORT FRAMEWORK FOR AGRICULTURAL AGGREGATION, BRANDING, AND DISTRIBUTION  
(74) NDUVIWA Loeobah Tafadzwa  
(75) NDUVIWA Loeobah Tafadzwa  
(84) ZW  
(96) 18.07.2025 AP/P/2025/016654
- ●
- (21) AP/P/2025/016655  
(22) 11.01.2024  
(23) 21.07.2025  
(31) 63/482,875  
(32) 02.02.2023 (33) US  
(51) **E02B 15/00 (2006.01)**  
**E02B 15/04 (2006.01)**  
**E04H 4/00 (2006.01)**  
**C02F 1/00 (2023.01)**  
**E02B 17/00 (2006.01)**  
**B01D 21/00 (2006.01)**  
(54) METHOD FOR CREATING GEOMETRIC FRESHWATER SANITARY AREAS WITHIN LARGE WATER BODIES  
(71) CRYSTAL LAGOONS TECHNOLOGIES, INC.  
(72) FISCHMANN Fernando  
(74) SPOOR.FISHER  
(84) BW, GH, KE, RW, TZ, UG, ZM, ZW  
(86) 11.01.2024 PCT/US2024/011211  
(96) 11.01.2024 AP/P/2025/016655
- ●
- (21) AP/P/2025/016656  
(22) 21.07.2025  
(23) 21.07.2025  
(31) 202411911423.9  
(32) 24.12.2024 (33) CN  
(51) **G06Q 10/0631 (2023.01)**  
**G06Q 10/087 (2023.01)**  
**G06T 17/00 (2006.01)**  
(54) GYPSUM MATERIAL DISTRIBUTION INFORMATION-BASED WAREHOUSE-OUT MATERIAL TAKING MANAGEMENT CONTROL SYSTEM AND METHOD  
(71) BEIJING NEW BUILDING MATERIALS PUBLIC LIMITED COMPANY and CHINA NATIONAL BUILDING MATERIALS TECHNOLOGICAL INNOVATION & RESEARCH INSTITUTE LIMITED COMPANY  
(72) WU Pengju, DONG Lei, ZHANG YuFei, et al  
(74) ROLAND INTELLECTUAL PROPERTY CONSULTANTS

- (84) TZ  
(96) 21.07.2025 AP/P/2025/016656
- ●
- (21) AP/P/2025/016657  
(22) 30.01.2024  
(23) 22.07.2025  
(31) 23154320.8  
(32) 31.01.2023 (33) EP  
(51) **E02F 9/26 (2006.01)**  
(54) PROVISION OF FEEDBACK TO AN OPERATOR OF A MINING VEHICLE  
(71) SANDVIK MINING AND CONSTRUCTION OY  
(72) MATTILA Esa  
(74) ADAMS AND ADAMS MOZAMBIQUE  
(84) GH, TZ, ZM, ZW  
(86) 30.01.2024 PCT/EP2024/052154  
(96) 30.01.2024 AP/P/2025/016657
- ●
- (21) AP/P/2025/016658  
(22) 13.02.2019  
(23) 22.07.2025  
(31) 62/792,122  
(32) 14.01.2019 (33) US  
(31) 62/782,659  
(32) 20.12.2018 (33) US  
(31) 62/772,228  
(32) 28.11.2018 (33) US  
(31) 62/792,122  
(32) 14.01.2019 (33) US  
(31) 62/739,402  
(32) 01.10.2018 (33) US  
(31) 62/782,659  
(32) 20.12.2018 (33) US  
(31) 62/772,228  
(32) 28.11.2018 (33) US  
(31) 62/739,402  
(32) 01.10.2018 (33) US  
(31) 62/726,608  
(32) 04.09.2018 (33) US  
(31) 62/691,366  
(32) 28.06.2018 (33) US  
(31) 62/630,385  
(32) 14.02.2018 (33) US  
(51) **H04N 19/46 (2014.01)**  
**H04N 19/107 (2014.01)**  
**H04N 19/117 (2014.01)**  
**N04N 19/503 (2014.01)**  
**H04N 19/159 (2014.01)**  
**H04N 19/176 (2014.01)**  
(54) IMAGE RESHAPING IN VIDEO CODING USING RATE DISTORTION OPTIMIZATION  
(71) DOLBY LABORATORIES LICENSING CORPORATION  
(72) MCCARTHY Sean Thomas, HUSAK Walter J, CHEN Tao, et al  
(74) SPOOR.FISHER  
(84) BW, GH, GM, KE, LR, LS, MW, MZ, NA, RW, SD, SL, ST, SZ, TZ, UG, ZM, ZW  
(86) 13.02.2019 PCT/US2019/017891  
(96) 13.02.2019 AP/P/2025/016658
- ●

- (21) AP/P/2025/016659  
(22) 26.12.2023  
(23) 22.07.2025  
(31) FR2214478  
(32) 23.12.2022 (33) FR  
(51) **C04B 28/00 (2006.01)**  
(54) CONSTRUCTION BINDER AND ASSOCIATED CONSTRUCTION MATERIAL  
(71) MATERRUP  
(72) TRINCAL Vincent, KRAMMER Devillard Julie, MERCE Manuel, et al  
(74) ISEME, KAMAU & MAEMA ADVOCATES  
(84) BW, GH, KE, NA, SD, TZ, UG, ZM  
(86) 26.12.2023 PCT/EP2023/087807  
(96) 26.12.2023 AP/P/2025/016659
- ●
- (21) AP/P/2025/016660  
(22) 21.12.2023  
(23) 22.07.2025  
(31) FR2214479  
(32) 23.12.2022 (33) FR  
(51) **C04B 28/02 (2006.01)**  
(54) LOW-CARBON CONSTRUCTION BINDER AND ASSOCIATED CONSTRUCTION MATERIAL  
(71) MATERRUP  
(72) TRINCAL Vincent, KRAMMER Devillard Julie, MERCE Manuel, et al  
(74) ISEME, KAMAU & MAEMA ADVOCATES  
(84) BW, GH, KE, NA, SD, TZ, UG, ZM  
(86) 21.12.2023 PCT/EP2023/087506  
(96) 21.12.2023 AP/P/2025/016660
- ●
- (21) AP/P/2025/016661  
(22) 23.01.2024  
(23) 23.07.2025  
(31) 10 2023 000 206.2  
(32) 24.01.2023 (33) DE  
(51) **F24D 3/16 (2006.01)**  
**A24D 3/14 (2006.01)**  
(54) PROFILE, PROFILE ARRANGEMENT AND TEMPERATURE CONTROL SYSTEM  
(71) BÜHLER Armin  
(72) BÜHLER Armin and HOFMAYR Johann  
(74) ADAMS AND ADAMS MOZAMBIQUE  
(84) BW, KE  
(86) 23.01.2024 PCT/EP2024/051571  
(96) 23.01.2024 AP/P/2025/016661
- ●

## Patent Applications Filed (Contd.)

(21) AP/P/2025/016662

(22) 08.02.2024

(23) 23.07.2025

(31) 63/484,075

(32) 09.02.2023 (33) US

(51) **H01L 21/04 (2006.01)****C30B 29/04 (2006.01)****H01L 21/265 (2006.01)****H01L 21/50 (2006.01)****C01B 32/28 (2017.01)****H01L 21/822 (2006.01)****H01L 21/02 (2006.01)**

(54) N-TYPE CARBON-BASED SEMICONDUCTOR SUBSTRATES AND METHODS OF PREPARING SAME

(71) ZERO RESISTANCE (PTY) LTD

(72) BADENHORST Jacques Christiaan, MYBURGH Willem Tobias and CLOETE André Christiaan

(74) Cronjé &amp; Co.

(84) BW, CV, GH, GM, KE, LR, LS, MW, MZ, NA, RW, SC, SD, SL, ST, SZ, TZ, UG, ZM, ZW

(86) 08.02.2024 PCT/IB2024/051150

(96) 08.02.2024 AP/P/2025/016662

● ●

(21) AP/P/2025/016663

(22) 13.10.2023

(23) 23.07.2025

(31) 2023/08056

(32) 21.08.2023 (33) ZA

(31) 2301325.3

(32) 30.01.2023 (33) GB

(51) **E04C 1/41 (2006.01)****E04C 2/288 (2006.01)**

(54) STRUCTURE AND CONSTRUCTION METHOD

(71) CITRA GROUP AG

(72) GRAF Andreas, BÜELER Benno and BAUR Joel

(74) Cronjé &amp; Co.

(84) BW, CV, GH, GM, KE, LR, LS, MW, MZ, NA, RW, SC, SD, SL, ST, SZ, TZ, UG, ZM, ZW

(86) 13.10.2023 PCT/IB2023/060338

(96) 13.10.2023 AP/P/2025/016663

● ●

(21) AP/P/2025/016664

(22) 08.01.2024

(23) 24.07.2025

(31) 63/479,045

(32) 09.01.2023 (33) US

(51) **H01M 10/0525 (2010.01)****B03B 9/00 (2006.01)****C22B 1/00 (2006.01)****B03C 1/02 (2006.01)****C01D 15/00 (2006.01)****B01D 37/00 (2006.01)****C01D 15/02 (2006.01)****C22B 26/12 (2006.01)****C01B 33/26 (2006.01)****B01D 21/00 (2006.01)**

(54) SPODUMENE CONCENTRATION FOR LITHIUM RECOVERY

(71) RIO TINTO IRON AND TITANIUM CANADA INC.

(72) BARTOLACCI Gianni, BELVAL Alex-Antoine and FILLION Mathieu

(74) SPOOR.FISHER

(84) BW, CV, GH, GM, KE, LR, LS, MW, MZ, NA, RW, SC, SD, SL, ST, SZ, TZ, UG, ZM, ZW

(86) 08.01.2024 PCT/CA2024/050016

(96) 08.01.2024 AP/P/2025/016664

● ●

(21) AP/P/2025/016665

(22) 29.01.2024

(23) 24.07.2025

(31) 20235101

(32) 03.02.2023 (33) FI

(51) **B07B 1/00 (2006.01)****B02C 21/02 (2006.01)****B60P 3/00 (2006.01)**

(54) MINERAL MATERIAL PROCESSING PLANT WITH MULTIFUNCTIONAL SUPPORT LEGS

(71) METSO FINLAND OY

(72) POHJA Jarno and SALO Lasse

(74) ROLAND INTELLECTUAL PROPERTY CONSULTANTS

(84) GH

(86) 29.01.2024 PCT/FI2024/050033

(96) 29.01.2024 AP/P/2025/016665

● ●

(21) AP/P/2025/016666

(22) 19.01.2024

(23) 25.07.2025

(31) 202310121195.4

(32) 15.02.2023 (33) CN

(31) 202310066299.X

(32) 19.01.2023 (33) CN

(51) **A61K 39/395 (2006.01)****A61K 31/519 (2006.01)****A61P 35/00 (2006.01)****A61K 47/68 (2017.01)****A61K 31/565 (2006.01)****A61K 31/4745 (2006.01)**

(54) ANTI-HER2 ANTIBODY-DRUG CONJUGATE FOR TREATING BREAST CANCER

(71) SHANGHAI SHENGDI PHARMACEUTICAL CO., LTD. and JIANGSU HENGRUI PHARMACEUTICALS CO., LTD.

(72) WANG Quanren

(74) SPOOR.FISHER

(84) BW, CV, GH, GM, KE, LR, LS, MW, MZ, NA, SC, SD, SL, ST, SZ, TZ, ZM, ZW

(86) 19.01.2024 PCT/CN2024/073246

(96) 19.01.2024 AP/P/2025/016666

● ●

(21) AP/P/2025/016667

(22) 20.12.2023

(23) 25.07.2025

(31) 23153405.8

(32) 26.01.2023 (33) EP

(51) **A23C 9/152 (2006.01)****A23L 2/52 (2006.01)****A23L 27/23 (2016.01)****A23C 9/13 (2006.01)****A23L 23/10 (2016.01)****A23L 33/165 (2016.01)****A23L 29/294 (2016.01)****A23L 33/13 (2016.01)**

(54) MINERAL-FORTIFIED FOOD PRODUCT

(71) UNILEVER IP HOLDINGS B.V.

(72) VINCKEN Jean-Paul, VELIKOV Krassimir Petkov, DE BRUIJN Wouter J C, et al

(74) SPOOR.FISHER

(84) KE

(86) 20.12.2023 PCT/EP2023/086971

(96) 20.12.2023 AP/P/2025/016667

● ●

(21) AP/P/2025/016668

(22) 31.01.2024

(23) 25.07.2025

(31) 63/482,404

(32) 31.01.2023 (33) US

(51) **A61P 3/04 (2006.01)****A61K 38/26 (2006.01)****A61P 3/10 (2006.01)****C07K 14/605 (2006.01)****A61K 47/54 (2017.01)****A61K 38/00 (2006.01)**

(54) GIP/GLP1/GCG TRI-RECEPTOR AGONISTS AND USES THEREOF

(71) ELI LILLY AND COMPANY

(72) WALLIS James Lincoln, QU Hongchang, QU Fucheng, et al

(74) ADAMS AND ADAMS MOZAMBIQUE

(84) BW, GH, KE, NA

(86) 31.01.2024 PCT/US2024/013645

(96) 31.01.2024 AP/P/2025/016668

● ●

(21) AP/P/2025/016669

(22) 02.02.2024

(23) 28.07.2025

(31) 63/503,087

(32) 18.05.2023 (33) US

(31) 63/483,000

(32) 02.02.2023 (33) US

(51) **A61P 11/06 (2006.01)****C07K 16/24 (2006.01)****A61P 37/08 (2006.01)****A61P 11/02 (2006.01)**

## Patent Applications Filed (Contd.)

- (54) TREATMENT OF CHRONIC RHINOSINUSITIS WITH ANTI-TSLP ANTIBODY
- (71) MEDIMMUNE, LLC  
(72) GRIFFITHS Janet  
(74) ADAMS AND ADAMS MOZAMBIQUE  
(84) BW  
(86) 02.02.2024 PCT/US2024/014361  
(96) 02.02.2024 AP/P/2025/016669
- ●
- (21) AP/P/2025/016670  
(22) 15.01.2024  
(23) 28.07.2025  
(31) 2023-004655  
(32) 16.01.2023 (33) JP
- (51) **A01P 5/00 (2006.01)**  
**A01N 65/08 (2009.01)**  
**A01N 43/50 (2006.01)**  
**A01N 65/38 (2009.01)**  
**A01N 43/78 (2006.01)**  
**A01N 37/44 (2006.01)**  
**A01N 59/16 (2006.01)**  
**A01N 43/08 (2006.01)**  
**A01N 37/42 (2006.01)**  
**A01N 59/06 (2006.01)**  
**A01M 17/00 (2006.01)**  
**A01N 59/02 (2006.01)**  
**A01N 45/02 (2006.01)**  
**A01N 37/36 (2006.01)**
- (54) SUBSTANCE (HATCHING ACCELERATOR) ACCELERATING HATCHING OF CYST NEMATODES
- (71) HIROTSU BIO SCIENCE INC.  
(72) TANIMOTO Ren and YOKOTA Shigefumi  
(74) SPOOR.FISHER  
(84) BW, CV, GH, GM, KE, LR, LS, MW, MZ, NA, RW, SC, SD, SL, ST, SZ, TZ, UG, ZM, ZW  
(86) 15.01.2024 PCT/JP2024/000726  
(96) 15.01.2024 AP/P/2025/016670
- ●
- (21) AP/P/2025/016671  
(22) 30.01.2024  
(23) 29.07.2025  
(31) 63/597,343  
(32) 09.11.2023 (33) US  
(31) 63/521,105  
(32) 15.06.2023 (33) US  
(31) 63/442,159  
(32) 31.01.2023 (33) US
- (51) **G06N 3/045 (2023.01)**  
**G06N 20/00 (2019.01)**  
**G10L 15/02 (2006.01)**  
**G10L 15/08 (2006.01)**
- (54) QUALITY ASSURANCE SYSTEMS BASED ON SPEAKER INTENT DETECTION
- (71) UJWAL INC.  
(72) KHULLAR Sumeet, TALWAR Abhimanyu, SINGH Tanul, et al  
(74) Galloway & Co (NA)  
(84) BW, CV, GH, GM, KE, LR, LS, MW, MZ, NA, RW, SC, SD, SL, ST, SZ, TZ, UG, ZM, ZW  
(86) 30.01.2024 PCT/US2024/013558  
(96) 30.01.2024 AP/P/2025/016671
- ●
- (21) AP/P/2025/016672  
(22) 12.01.2024  
(23) 29.07.2025  
(31) 202341002592  
(32) 12.01.2023 (33) IN
- (51) **G05B 19/048 (2006.01)**  
**B60L 53/80 (2019.01)**  
**B60L 53/60 (2019.01)**  
**G05B 23/02 (2006.01)**
- (54) SAFETY AND SECURITY MECHANISMS FOR A BATTERY CHARGING AND SWAPPING STATION
- (71) SUN MOBILITY PTE LTD  
(72) GUNJAN Kumar, MAINI Chetan Kumar, GOPALAKRISHNAN Arvind, et al  
(74) Galloway & Co (NA)  
(84) KE, UG  
(86) 12.01.2024 PCT/SG2024/050026  
(96) 12.01.2024 AP/P/2025/016672
- ●
- (21) AP/P/2025/016673  
(22) 26.01.2023  
(23) 29.07.2025  
(51) **H04W 12/121 (2021.01)**
- (54) ATTACKER IDENTIFICATION DURING SMALL DATA TRANSMISSION
- (71) NOKIA TECHNOLOGIES OY  
(72) WU Chunli, KOSKINEN Jussi-Pekka and TURTINEN Samuli Heikki  
(74) Galloway & Co (NA)  
(84) GH, KE, MZ, TZ, UG  
(86) 26.01.2023 PCT/CN2023/073479  
(96) 26.01.2023 AP/P/2025/016673
- ●
- (21) AP/P/2025/016674  
(22) 02.02.2024  
(23) 29.07.2025  
(31) 2301522.5  
(32) 02.02.2023 (33) GB
- (51) **A61P 31/04 (2006.01)**  
**C12N 9/22 (2006.01)**  
**A61K 39/04 (2006.01)**  
**C07K 14/35 (2006.01)**
- (54) MODIFIED BCG VACCINE
- (71) UNIVERSITY OF THE WITWATERSRAND, JOHANNESBURG  
(72) SHAKU Tube Moagi and KANA Bavesh Davandra  
(74) SPOOR.FISHER  
(84) BW, KE, MZ, ZW  
(86) 02.02.2024 PCT/IB2024/050966  
(96) 02.02.2024 AP/P/2025/016674
- ●
- (21) AP/P/2025/016675  
(22) 11.01.2024  
(23) 29.07.2025  
(31) 202341002598  
(32) 12.01.2023 (33) IN
- (51) **B60L 53/80 (2019.01)**  
**B60L 53/30 (2019.01)**  
**H01M 50/204 (2021.01)**
- (54) A PORTABLE BATTERY CHARGING AND SWAPPING STATION
- (71) SUN MOBILITY PTE LTD  
(72) REVANNA Yatheesha, GUNDE Jagdish, MAINI Chetan Kumar, et al  
(74) Galloway & Co (NA)  
(84) KE, UG  
(86) 11.01.2024 PCT/SG2024/050019  
(96) 11.01.2024 AP/P/2025/016675
- ●
- (21) AP/P/2025/016676  
(22) 12.01.2024  
(23) 29.07.2025  
(31) 202341002651  
(32) 12.01.2023 (33) IN
- (51) **B60L 53/67 (2019.01)**
- (54) A MODULAR BATTERY CHARGING AND SWAPPING STATION AND ITS METHODS OF OPERATION THEREOF
- (71) SUN MOBILITY PTE LTD  
(72) GOPALAKRISHNAN Arvind, MAINI Chetan Kumar, S Karthikeyan, et al  
(74) Galloway & Co (NA)  
(84) KE, UG  
(86) 12.01.2024 PCT/SG2024/050024  
(96) 12.01.2024 AP/P/2025/016676
- ●
- (21) AP/P/2025/016677  
(22) 30.01.2024  
(23) 29.07.2025  
(31) 23180646.4  
(32) 21.06.2023 (33) EP  
(31) 23154427.1  
(32) 01.02.2023 (33) EP
- (51) **A01P 3/00 (2006.01)**  
**A01N 43/82 (2006.01)**  
**A01N 43/80 (2006.01)**
- (54) FUNGICIDAL COMPOSITIONS
- (71) SYNGENTA CROP PROTECTION AG  
(72) GRASSO Valeria, WOLF Hanno Christian, SCARBOROUGH Christopher Charles, et al  
(74) ADAMS AND ADAMS MOZAMBIQUE  
(84) GH, KE  
(86) 30.01.2024 PCT/EP2024/052205  
(96) 30.01.2024 AP/P/2025/016677
- ●

## Patent Applications Filed (Contd.)

- (21) AP/P/2025/016678  
 (22) 18.09.2024  
 (23) 30.07.2025  
 (31) 2023/09022  
 (32) 26.09.2023 (33) ZA  
 (51) **B03D 1/01 (2006.01)**  
**B03D 1/002 (2006.01)**  
**B03D 1/018 (2006.01)**  
 (54) BENEFICIATION OF AN ORE BEARING ONE OR MORE SULPHIDE MINERALS  
 (71) BETACHEM (PROPRIETARY) LIMITED  
 (72) GROBLER Elze and NEL Diderik Johannes  
 (74) ADAMS AND ADAMS MOZAMBIQUE  
 (84) BW, NA, TZ, ZM, ZW  
 (86) 18.09.2024 PCT/IB2024/059053  
 (96) 18.09.2024 AP/P/2025/016678
- ●
- (21) AP/P/2025/016679  
 (22) 01.02.2024  
 (23) 30.07.2025  
 (31) 63/483,140  
 (32) 03.02.2023 (33) US  
 (51) **C07K 7/54 (2006.01)**  
**A61P 37/00 (2006.01)**  
**C07K 7/08 (2006.01)**  
**A61P 19/02 (2006.01)**  
 (54) CYCLIC PEPTIDES FOR INHIBITING TNF RECEPTOR 1 ACTIVITY  
 (71) MERCK SHARP & DOHME LLC  
 (72) WUO Michael, CHAU Ryan, TOZZI Roberta, et al  
 (74) ADAMS AND ADAMS MOZAMBIQUE  
 (84) BW, GH, KE, NA, SC  
 (86) 01.02.2024 PCT/US2024/013911  
 (96) 01.02.2024 AP/P/2025/016679
- ●
- (21) AP/P/2025/016680  
 (22) 03.01.2024  
 (23) 30.07.2025  
 (31) 63/478,409  
 (32) 04.01.2023 (33) US  
 (51) **C07D 487/10 (2006.01)**  
**A61P 25/06 (2006.01)**  
 (54) SOLID STATE FORMS OF MNK INHIBITORS  
 (71) 4E THERAPEUTICS, INC.  
 (72) SMITH Garry Robert, CASTELHANO Arlindo Lucas, SULEIMAN Osama, et al  
 (74) SPOOR.FISHER  
 (84) BW, CV, GH, GM, KE, LR, LS, MW, MZ, NA, RW, SC, SD, SL, ST, SZ, TZ, UG, ZM, ZW  
 (86) 03.01.2024 PCT/US2024/010110  
 (96) 03.01.2024 AP/P/2025/016680
- ●

- (21) AP/P/2025/016681  
 (22) 30.11.2023  
 (23) 01.08.2025  
 (31) 20235119  
 (32) 07.02.2023 (33) FI  
 (51) **H04W 56/00 (2009.01)**  
 (54) SIDELINK SYNCHRONIZATION DURING USER EQUIPMENT SELECTION  
 (71) NOKIA TECHNOLOGIES OY  
 (72) CHIARELLO Leonardo, MICHALOPOULOS Diomidis, KESHAVAMURTHY Prajwal, et al  
 (74) Galloway & Co (NA)  
 (84) GH, KE, MZ, TZ, UG  
 (86) 30.11.2023 PCT/EP2023/083729  
 (96) 30.11.2023 AP/P/2025/016681

- ●
- (21) AP/P/2025/016682  
 (22) 26.01.2024  
 (23) 31.07.2025  
 (31) 2023-043546  
 (32) 17.03.2023 (33) JP  
 (51) **A41G 5/00 (2006.01)**  
**A41G 3/00 (2006.01)**  
**B26D 3/02 (2006.01)**  
 (54) FIBER BUNDLE FOR ARTIFICIAL HAIR  
 (71) KANEKA CORPORATION  
 (72) NAKAMURA Yu and KANO Aki  
 (74) ROLAND INTELLECTUAL PROPERTY CONSULTANTS  
 (84) GH, KE, MZ, TZ  
 (86) 26.01.2024 PCT/JP2024/002474  
 (96) 26.01.2024 AP/P/2025/016682

- ●
- (21) AP/P/2025/016683  
 (22) 01.02.2024  
 (23) 31.07.2025  
 (31) 23015563  
 (32) 03.02.2023 (33) GB  
 (51) **G01B 11/00 (2006.01)**  
**G01B 9/02091 (2022.01)**  
**G01N 21/87 (2006.01)**  
**G01N 21/47 (2006.01)**  
 (54) OPTICAL COHERENCE TOMOGRAPHY SCANNING OF GEMSTONES  
 (71) DE BEERS UK LTD  
 (72) POWELL Graham, MARTINS Maria Cristina and LANIGAN Peter  
 (74) ADAMS AND ADAMS MOZAMBIQUE  
 (84) BW, NA  
 (86) 01.02.2024 PCT/EP2024/052485  
 (96) 01.02.2024 AP/P/2025/016683

## Erratum: Patent Applications Filed

The patent application below, which was published in the May 2025 issue of the ARIPO Journal has been amended by the applicant to remove Namibia from the designated states. The applicant advised that the inclusion of Namibia was done in error. We republish the application below with the correct designations.

- (21) AP/P/2025/016538  
 (22) 22.11.2023  
 (23) 22.05.2025  
 (31) 22208894.0  
 (32) 22.11.2022 (33) EP  
 (51) **C07C 273/02 (2006.01)**  
**B01J 6/00 (2006.01)**  
**C07D 251/60 (2006.01)**  
**C07D 251/62 (2006.01)**  
 (54) COUPLED UREA MELAMINE PLANT  
 (71) STAMICARBON B.V.  
 (72) PATIL Rahul  
 (74) HONEY & BLANCKENBERG  
 (84) GH, KE, MZ, TZ  
 (86) 22.11.2023 PCT/NL2023/050610  
 (96) 22.11.2023 AP/P/2025/016538

● ●

■

## Patent Applications Renewed

Application No.	Date Fee Paid	Valid Until	Anniversary	
AP/P/2016/009655	23.06.2025	29.07.2026	10th	yr
AP/P/2019/011383	16.07.2025	31.07.2026	8th	yr
AP/P/2019/012091	01.07.2025	20.08.2026	7th	yr
AP/P/2020/012190	25.07.2025	03.08.2026	7th	yr
AP/P/2020/012221	30.06.2025	14.07.2026	8th	yr
AP/P/2020/012612	24.06.2025	18.08.2026	5th	yr
AP/P/2020/012613	24.06.2025	18.08.2026	5th	yr
AP/P/2021/012931	11.07.2025	17.07.2026	6th	yr
AP/P/2021/012970	25.07.2025	02.08.2026	7th	yr
AP/P/2021/012979	15.07.2025	15.07.2026	6th	yr
AP/P/2021/013460	08.07.2025	31.08.2026	4th	yr
AP/P/2021/013665	22.06.2025	26.06.2026	5th	yr
AP/P/2021/013694	16.07.2025	06.05.2022	1st	yr
AP/P/2021/013697	17.07.2025	19.04.2019	1st	yr
AP/P/2021/013698	18.07.2025	15.11.2015	1st	yr
AP/P/2021/013723	28.07.2025	27.08.2026	5th	yr
AP/P/2022/013760	11.07.2025	07.08.2026	5th	yr
AP/P/2022/013770	27.06.2025	06.07.2026	5th	yr
AP/P/2022/013782	02.07.2025	02.07.2026	5th	yr
AP/P/2022/013783	27.06.2025	14.08.2026	5th	yr
AP/P/2022/013785	24.07.2025	29.07.2026	5th	yr
AP/P/2022/013786	24.07.2025	31.07.2026	5th	yr
AP/P/2022/013795	04.07.2025	27.07.2026	6th	yr
AP/P/2022/013823	07.07.2025	22.06.2026	5th	yr
AP/P/2022/013826	04.07.2025	10.08.2026	5th	yr
AP/P/2022/013830	14.07.2025	20.08.2026	5th	yr
AP/P/2022/013834	11.07.2025	13.07.2026	5th	yr
AP/P/2022/013840	01.07.2025	01.07.2026	5th	yr
AP/P/2022/013852	23.07.2025	24.07.2026	5th	yr
AP/P/2022/013855	14.07.2025	07.08.2026	6th	yr
AP/P/2022/013867	14.07.2025	28.08.2026	5th	yr
AP/P/2022/013868	28.07.2025	07.08.2026	5th	yr
AP/P/2022/013876	28.07.2025	03.08.2026	5th	yr
AP/P/2022/013887	28.07.2025	11.09.2026	5th	yr

## Patent Applications Renewed (Contd.)

Application No.	Date Fee Paid	Valid Until	Anniversary	
AP/P/2022/013888	28.07.2025	11.09.2026	5th	yr
AP/P/2022/013932	14.07.2025	24.08.2026	5th	yr
AP/P/2022/013932	18.07.2025	24.08.2022	1st	yr
AP/P/2022/014050	29.07.2025	24.11.2022	1st	yr
AP/P/2022/014099	11.07.2025	16.07.2026	13th	yr
AP/P/2022/014246	10.07.2025	11.01.2026	4th	yr
AP/P/2022/014300	04.07.2025	02.09.2026	3rd	yr
AP/P/2022/014316	30.07.2025	04.03.2022	1st	yr
AP/P/2022/014316	30.07.2025	04.03.2022	1st	yr
AP/P/2022/014421	03.07.2025	25.03.2026	4th	yr
AP/P/2022/014512	08.07.2025	09.07.2026	4th	yr
AP/P/2022/014541	30.07.2025	23.06.2026	4th	yr
AP/P/2022/014541	30.07.2025	23.06.2023	1st	yr
AP/P/2022/014553	28.07.2025	05.08.2026	4th	yr
AP/P/2022/014566	15.07.2025	14.07.2026	4th	yr
AP/P/2022/014575	30.06.2025	30.06.2026	4th	yr
AP/P/2022/014608	30.07.2025	09.06.2022	1st	yr
AP/P/2022/014608	30.07.2025	09.06.2022	1st	yr
AP/P/2023/014615	30.06.2025	09.07.2026	4th	yr
AP/P/2023/014621	30.06.2025	04.06.2026	4th	yr
AP/P/2023/014626	10.07.2025	10.07.2026	4th	yr
AP/P/2023/014629	25.07.2025	04.08.2026	4th	yr
AP/P/2023/014631	14.07.2025	15.07.2026	5th	yr
AP/P/2023/014635	15.07.2025	16.07.2026	4th	yr
AP/P/2023/014644	25.06.2025	19.07.2026	4th	yr
AP/P/2023/014646	15.07.2025	16.07.2026	4th	yr
AP/P/2023/014647	22.07.2025	23.07.2026	4th	yr
AP/P/2023/014658	08.07.2025	19.07.2026	4th	yr
AP/P/2023/014663	04.07.2025	23.08.2026	4th	yr
AP/P/2023/014674	27.06.2025	12.07.2026	4th	yr
AP/P/2023/014681	28.07.2025	24.08.2026	4th	yr
AP/P/2023/014681	29.07.2025	24.08.2023	1st	yr
AP/P/2023/014685	28.07.2025	21.08.2026	8th	yr
AP/P/2023/014686	04.07.2025	23.08.2026	4th	yr

## Patent Applications Renewed (Contd.)

Application No.	Date Fee Paid	Valid Until	Anniversary	
AP/P/2023/014687	04.07.2025	26.08.2026	4th	yr
AP/P/2023/014691	11.07.2025	13.07.2026	4th	yr
AP/P/2023/014695	27.06.2025	27.07.2026	4th	yr
AP/P/2023/014700	28.07.2025	17.08.2026	4th	yr
AP/P/2023/014703	28.07.2025	13.08.2026	4th	yr
AP/P/2023/014708	25.07.2025	30.07.2026	4th	yr
AP/P/2023/014712	14.07.2025	26.08.2026	5th	yr
AP/P/2023/014714	14.07.2025	23.08.2026	4th	yr
AP/P/2023/014717	24.07.2025	30.07.2026	4th	yr
AP/P/2023/014718	21.07.2025	27.07.2026	5th	yr
AP/P/2023/014721	04.07.2025	23.07.2026	4th	yr
AP/P/2023/014723	24.07.2025	29.07.2026	4th	yr
AP/P/2023/014732	27.06.2025	06.08.2026	4th	yr
AP/P/2023/014734	24.07.2025	14.09.2026	5th	yr
AP/P/2023/014737	21.07.2025	07.09.2026	4th	yr
AP/P/2023/014768	11.07.2025	16.08.2026	4th	yr
AP/P/2023/014783	28.07.2025	15.09.2026	4th	yr
AP/P/2023/014789	28.07.2025	11.08.2026	4th	yr
AP/P/2023/014847	30.07.2025	21.06.2020	1st	yr
AP/P/2023/014847	30.07.2025	21.06.2026	7th	yr
AP/P/2023/014894	28.07.2025	25.08.2026	4th	yr
AP/P/2023/014901	28.07.2025	09.11.2026	4th	yr
AP/P/2023/014902	30.06.2025	29.06.2026	5th	yr
AP/P/2023/014904	30.06.2025	29.06.2026	5th	yr
AP/P/2023/014905	30.06.2025	29.06.2026	5th	yr
AP/P/2023/014906	30.06.2025	29.06.2026	5th	yr
AP/P/2023/014914	30.07.2025	27.10.2023	1st	yr
AP/P/2023/014914	28.07.2025	27.10.2026	4th	yr
AP/P/2023/014914	30.07.2025	27.10.2023	1st	yr
AP/P/2023/015000	01.07.2025	02.07.2026	6th	yr
AP/P/2023/015064	28.07.2025	11.08.2026	2nd	yr
AP/P/2023/015079	28.07.2025	19.10.2026	4th	yr
AP/P/2023/015144	04.07.2025	23.08.2026	8th	yr
AP/P/2023/015150	04.07.2025	09.02.2026	3rd	yr

## Patent Applications Renewed (Contd.)

Application No.	Date Fee Paid	Valid Until	Anniversary	
AP/P/2023/015168	01.07.2025	06.07.2026	5th	yr
AP/P/2023/015204	27.06.2025	26.07.2026	8th	yr
AP/P/2023/015368	25.07.2025	13.06.2024	1st	yr
AP/P/2023/015368	25.07.2025	13.06.2026	3rd	yr
AP/P/2023/015380	02.07.2025	02.05.2026	3rd	yr
AP/P/2023/015382	25.07.2025	01.08.2026	3rd	yr
AP/P/2023/015415	22.06.2025	28.06.2026	3rd	yr
AP/P/2023/015416	28.07.2025	09.11.2026	4th	yr
AP/P/2024/015423	08.07.2025	29.06.2026	3rd	yr
AP/P/2024/015442	23.07.2025	08.07.2026	3rd	yr
AP/P/2024/015447	04.07.2025	04.07.2026	3rd	yr
AP/P/2024/015448	08.07.2025	13.07.2026	3rd	yr
AP/P/2024/015452	01.07.2025	08.07.2026	3rd	yr
AP/P/2024/015454	30.06.2025	13.07.2026	3rd	yr
AP/P/2024/015462	27.06.2025	18.08.2026	3rd	yr
AP/P/2024/015464	08.07.2025	29.06.2026	3rd	yr
AP/P/2024/015474	21.07.2025	20.07.2026	3rd	yr
AP/P/2024/015475	30.06.2025	15.07.2026	3rd	yr
AP/P/2024/015476	30.06.2025	15.07.2026	3rd	yr
AP/P/2024/015477	30.06.2025	15.07.2026	3rd	yr
AP/P/2024/015478	30.06.2025	15.07.2026	3rd	yr
AP/P/2024/015480	25.06.2025	24.06.2026	3rd	yr
AP/P/2024/015481	30.06.2025	15.07.2026	3rd	yr
AP/P/2024/015482	28.07.2025	27.10.2026	4th	yr
AP/P/2024/015487	27.06.2025	29.07.2026	3rd	yr
AP/P/2024/015492	11.07.2025	28.07.2026	3rd	yr
AP/P/2024/015493	14.07.2025	29.07.2026	3rd	yr
AP/P/2024/015494	24.07.2025	29.07.2026	3rd	yr
AP/P/2024/015495	04.07.2025	15.07.2026	3rd	yr
AP/P/2024/015496	14.07.2025	01.08.2026	3rd	yr
AP/P/2024/015497	23.06.2025	04.07.2026	3rd	yr
AP/P/2024/015497	23.06.2025	04.07.2025	2nd	yr
AP/P/2024/015499	04.07.2025	04.08.2026	3rd	yr
AP/P/2024/015500	14.07.2025	01.08.2026	3rd	yr

## Patent Applications Renewed (Contd.)

Application No.	Date Fee Paid	Valid Until	Anniversary	
AP/P/2024/015501	07.07.2025	22.07.2026	3rd	yr
AP/P/2024/015504	24.07.2025	28.07.2026	3rd	yr
AP/P/2024/015506	30.06.2025	08.07.2026	3rd	yr
AP/P/2024/015510	25.07.2025	05.08.2026	3rd	yr
AP/P/2024/015516	14.07.2025	19.07.2026	3rd	yr
AP/P/2024/015521	30.06.2025	13.07.2026	3rd	yr
AP/P/2024/015524	27.06.2025	19.07.2026	3rd	yr
AP/P/2024/015530	14.07.2025	04.08.2026	3rd	yr
AP/P/2024/015532	30.06.2025	30.06.2026	3rd	yr
AP/P/2024/015533	04.07.2025	23.08.2026	3rd	yr
AP/P/2024/015534	21.07.2025	21.07.2026	3rd	yr
AP/P/2024/015541	10.07.2025	15.08.2026	3rd	yr
AP/P/2024/015546	25.07.2025	01.08.2026	3rd	yr
AP/P/2024/015557	25.07.2025	04.08.2026	3rd	yr
AP/P/2024/015569	14.07.2025	02.08.2026	6th	yr
AP/P/2024/015573	27.06.2025	15.08.2026	3rd	yr
AP/P/2024/015577	28.07.2025	17.08.2026	3rd	yr
AP/P/2024/015584	23.07.2025	18.08.2026	3rd	yr
AP/P/2024/015587	14.07.2025	17.08.2026	3rd	yr
AP/P/2024/015612	17.07.2025	12.09.2026	3rd	yr
AP/P/2024/015688	18.07.2025	28.05.2022	1st	yr
AP/P/2024/015735	16.07.2025	04.08.2026	3rd	yr
AP/P/2024/015738	22.07.2025	22.07.2026	6th	yr
AP/P/2024/015862	22.07.2025	22.07.2026	1st	yr
AP/P/2024/015956	02.07.2025	15.02.2026	2nd	yr
AP/P/2024/016037	30.07.2025	31.03.2019	1st	yr
AP/P/2024/016037	30.07.2025	31.03.2026	8th	yr
AP/P/2024/016093	22.07.2025	22.07.2026	6th	yr
AP/P/2024/016190	01.07.2025	04.07.2026	2nd	yr
AP/P/2025/016198	11.06.2025	09.06.2026	2nd	yr
AP/P/2025/016210	07.07.2025	12.08.2026	3rd	yr
AP/P/2025/016211	14.07.2025	20.07.2026	2nd	yr
AP/P/2025/016214	23.07.2025	26.07.2026	2nd	yr
AP/P/2025/016215	03.07.2025	20.07.2026	2nd	yr

## Patent Applications Renewed (Contd.)

Application No.	Date Fee Paid	Valid Until	Anniversary	
AP/P/2025/016219	23.07.2025	24.07.2026	2nd	yr
AP/P/2025/016227	14.07.2025	08.08.2026	2nd	yr
AP/P/2025/016228	07.07.2025	07.07.2026	2nd	yr
AP/P/2025/016229	25.07.2025	03.08.2026	7th	yr
AP/P/2025/016231	25.07.2025	03.08.2026	7th	yr
AP/P/2025/016232	25.07.2025	03.08.2026	7th	yr
AP/P/2025/016233	25.07.2025	03.08.2026	7th	yr
AP/P/2025/016234	14.07.2025	01.08.2026	3rd	yr
AP/P/2025/016237	14.07.2025	05.08.2026	3rd	yr
AP/P/2025/016247	01.07.2025	03.07.2026	2nd	yr
AP/P/2025/016255	14.07.2025	08.08.2026	3rd	yr
AP/P/2025/016258	14.07.2025	10.08.2026	3rd	yr
AP/P/2025/016260	22.06.2025	11.07.2026	2nd	yr
AP/P/2025/016262	25.07.2025	05.08.2026	2nd	yr
AP/P/2025/016263	14.07.2025	08.08.2026	3rd	yr
AP/P/2025/016265	14.07.2025	12.08.2026	3rd	yr
AP/P/2025/016267	14.07.2025	09.08.2026	2nd	yr
AP/P/2025/016268	14.07.2025	04.08.2026	2nd	yr
AP/P/2025/016275	14.07.2025	11.08.2026	3rd	yr
AP/P/2025/016276	14.07.2025	22.08.2026	3rd	yr
AP/P/2025/016278	14.07.2025	01.08.2026	2nd	yr
AP/P/2025/016279	14.07.2025	25.08.2026	2nd	yr
AP/P/2025/016281	14.07.2025	02.08.2026	2nd	yr
AP/P/2025/016282	14.07.2025	25.08.2026	2nd	yr
AP/P/2025/016284	14.07.2025	07.08.2026	2nd	yr
AP/P/2025/016287	04.07.2025	26.07.2026	2nd	yr
AP/P/2025/016289	14.07.2025	08.08.2026	3rd	yr
AP/P/2025/016294	14.07.2025	15.08.2026	3rd	yr
AP/P/2025/016295	14.07.2025	14.07.2026	2nd	yr
AP/P/2025/016296	27.06.2025	15.08.2026	2nd	yr
AP/P/2025/016297	10.07.2025	26.07.2026	2nd	yr
AP/P/2025/016298	25.07.2025	14.07.2026	2nd	yr
AP/P/2025/016300	14.07.2025	14.07.2026	2nd	yr
AP/P/2025/016301	04.07.2025	19.07.2026	2nd	yr

## Patent Applications Renewed (Contd.)

Application No.	Date Fee Paid	Valid Until	Anniversary	
AP/P/2025/016304	04.07.2025	26.07.2026	2nd	yr
AP/P/2025/016312	07.07.2025	18.07.2026	2nd	yr
AP/P/2025/016313	18.07.2025	03.08.2026	2nd	yr
AP/P/2025/016316	14.07.2025	03.08.2026	2nd	yr
AP/P/2025/016317	07.07.2025	07.07.2026	2nd	yr
AP/P/2025/016326	16.07.2025	27.07.2026	2nd	yr
AP/P/2025/016328	18.07.2025	17.08.2026	2nd	yr
AP/P/2025/016329	28.07.2025	29.08.2026	2nd	yr
AP/P/2025/016341	14.07.2025	31.08.2026	2nd	yr
AP/P/2025/016344	14.07.2025	14.08.2026	2nd	yr
AP/P/2025/016345	21.07.2025	27.07.2026	2nd	yr
AP/P/2025/016346	08.07.2025	28.07.2026	2nd	yr
AP/P/2025/016350	04.07.2025	17.07.2026	2nd	yr
AP/P/2025/016360	24.07.2025	27.07.2026	2nd	yr
AP/P/2025/016374	14.07.2025	16.08.2026	2nd	yr
AP/P/2025/016397	14.07.2025	28.08.2026	2nd	yr
AP/P/2025/016424	25.06.2025	01.08.2026	2nd	yr
AP/P/2025/016471	10.07.2025	11.07.2026	2nd	yr
AP/P/2025/016480	18.06.2025	05.07.2026	2nd	yr
AP/P/2025/016480	18.06.2025	05.07.2025	1st	yr
AP/P/2025/016535	18.07.2025	21.05.2027	1st	yr
AP/P/2025/016535	18.07.2025	21.05.2027	1st	yr
AP/P/2025/016554	22.06.2025	07.11.2025	1st	yr
AP/P/2025/016556	17.07.2025	01.11.2025	1st	yr
AP/P/2025/016557	27.06.2025	07.11.2024	1st	yr
AP/P/2025/016557	27.06.2025	07.11.2025	2nd	yr
AP/P/2025/016559	27.06.2025	27.10.2026	2nd	yr
AP/P/2025/016559	27.06.2025	27.10.2025	1st	yr
AP/P/2025/016562	27.06.2025	13.11.2024	1st	yr
AP/P/2025/016562	27.06.2025	13.11.2025	2nd	yr
AP/P/2025/016568	03.07.2025	07.11.2025	1st	yr
AP/P/2025/016569	03.07.2025	07.11.2025	1st	yr
AP/P/2025/016570	03.07.2025	07.12.2024	1st	yr
AP/P/2025/016570	03.07.2025	07.12.2025	2nd	yr

## Patent Applications Renewed (Contd.)

Application No.	Date Fee Paid	Valid Until	Anniversary	
AP/P/2025/016572	10.07.2025	30.10.2026	2nd	yr
AP/P/2025/016572	10.07.2025	30.10.2025	1st	yr
AP/P/2025/016573	09.07.2025	07.11.2025	1st	yr
AP/P/2025/016573	09.07.2025	07.11.2025	1st	yr
AP/P/2025/016573	09.07.2025	07.11.2025	1st	yr
AP/P/2025/016573	09.07.2025	07.11.2025	1st	yr
AP/P/2025/016576	10.07.2025	08.12.2025	1st	yr
AP/P/2025/016578	10.07.2025	22.12.2025	1st	yr
AP/P/2025/016582	02.07.2025	12.12.2025	1st	yr
AP/P/2025/016585	01.07.2025	21.12.2025	1st	yr
AP/P/2025/016586	23.06.2025	20.12.2025	1st	yr
AP/P/2025/016587	27.06.2025	06.03.2026	1st	yr
AP/P/2025/016587	27.06.2025	06.03.2027	2nd	yr
AP/P/2025/016588	23.06.2025	27.12.2025	2nd	yr
AP/P/2025/016588	23.06.2025	27.12.2024	1st	yr
AP/P/2025/016590	11.07.2025	23.11.2025	1st	yr
AP/P/2025/016591	11.07.2025	23.11.2025	1st	yr
AP/P/2025/016592	01.07.2025	08.12.2025	1st	yr
AP/P/2025/016593	14.07.2025	20.06.2027	1st	yr
AP/P/2025/016594	27.06.2025	05.12.2025	1st	yr
AP/P/2025/016595	27.06.2025	04.12.2025	1st	yr
AP/P/2025/016596	27.06.2025	04.12.2025	1st	yr
AP/P/2025/016597	23.06.2025	20.12.2025	1st	yr
AP/P/2025/016598	01.07.2025	23.11.2025	1st	yr
AP/P/2025/016599	15.07.2025	05.12.2025	1st	yr
AP/P/2025/016600	25.06.2025	22.12.2025	1st	yr
AP/P/2025/016601	25.06.2025	27.12.2024	1st	yr
AP/P/2025/016601	25.06.2025	27.12.2025	2nd	yr
AP/P/2025/016602	27.06.2025	22.12.2025	1st	yr
AP/P/2025/016603	25.06.2025	22.12.2025	1st	yr
AP/P/2025/016604	01.07.2025	18.10.2026	1st	yr
AP/P/2025/016605	01.07.2025	23.01.2026	1st	yr
AP/P/2025/016606	27.06.2025	07.12.2025	1st	yr
AP/P/2025/016607	01.07.2025	27.11.2025	1st	yr

## Patent Applications Renewed (Contd.)

Application No.	Date Fee Paid	Valid Until	Anniversary	
AP/P/2025/016608	27.06.2025	18.04.2025	1st	yr
AP/P/2025/016608	27.06.2025	18.04.2026	2nd	yr
AP/P/2025/016609	01.07.2025	27.11.2025	1st	yr
AP/P/2025/016610	17.07.2025	24.11.2025	1st	yr
AP/P/2025/016610	17.07.2025	24.11.2026	2nd	yr
AP/P/2025/016611	11.07.2025	22.12.2025	1st	yr
AP/P/2025/016612	27.06.2025	05.12.2025	1st	yr
AP/P/2025/016613	27.06.2025	23.08.2025	1st	yr
AP/P/2025/016613	27.06.2025	23.08.2026	2nd	yr
AP/P/2025/016614	01.07.2025	30.11.2025	1st	yr
AP/P/2025/016615	02.07.2025	22.12.2025	1st	yr
AP/P/2025/016616	14.07.2025	23.06.2023	1st	yr
AP/P/2025/016616	14.07.2025	23.06.2024	2nd	yr
AP/P/2025/016616	14.07.2025	23.06.2025	3rd	yr
AP/P/2025/016616	14.07.2025	23.06.2026	4th	yr
AP/P/2025/016619	15.07.2025	11.09.2025	4th	yr
AP/P/2025/016619	15.07.2025	11.09.2024	3rd	yr
AP/P/2025/016619	15.07.2025	11.09.2023	2nd	yr
AP/P/2025/016619	15.07.2025	11.09.2022	1st	yr
AP/P/2025/016621	11.07.2025	01.08.2025	1st	yr
AP/P/2025/016622	24.07.2025	24.11.2025	1st	yr
AP/P/2025/016622	24.07.2025	24.11.2025	1st	yr
AP/P/2025/016622	24.07.2025	24.11.2025	1st	yr
AP/P/2025/016624	04.07.2025	19.12.2025	1st	yr
AP/P/2025/016625	09.07.2025	26.12.2025	1st	yr
AP/P/2025/016626	04.07.2025	05.12.2025	1st	yr
AP/P/2025/016627	10.07.2025	29.11.2025	1st	yr
AP/P/2025/016628	21.07.2025	11.01.2026	1st	yr
AP/P/2025/016629	14.07.2025	18.12.2025	1st	yr
AP/P/2025/016630	09.07.2025	09.01.2026	1st	yr
AP/P/2025/016631	08.07.2025	18.12.2025	1st	yr
AP/P/2025/016632	14.07.2025	05.05.2025	1st	yr
AP/P/2025/016632	14.07.2025	05.05.2026	2nd	yr
AP/P/2025/016633	18.07.2025	15.01.2026	1st	yr

## Patent Applications Renewed (Contd.)

Application No.	Date Fee Paid	Valid Until	Anniversary	
AP/P/2025/016635	14.07.2025	12.01.2026	1st	yr
AP/P/2025/016636	08.07.2025	12.07.2025	1st	yr
AP/P/2025/016636	08.07.2025	12.07.2026	2nd	yr
AP/P/2025/016637	16.07.2025	11.01.2026	1st	yr
AP/P/2025/016639	16.07.2025	15.12.2025	1st	yr
AP/P/2025/016640	28.07.2025	14.12.2025	1st	yr
AP/P/2025/016641	16.07.2025	16.01.2026	1st	yr
AP/P/2025/016642	16.07.2025	13.12.2025	1st	yr
AP/P/2025/016643	16.07.2025	13.12.2025	1st	yr
AP/P/2025/016644	21.07.2025	26.01.2026	1st	yr
AP/P/2025/016645	28.07.2025	26.01.2026	1st	yr
AP/P/2025/016646	18.07.2025	08.01.2026	1st	yr
AP/P/2025/016650	18.07.2025	26.12.2025	1st	yr
AP/P/2025/016651	18.07.2025	15.02.2026	1st	yr
AP/P/2025/016652	18.07.2025	27.02.2026	1st	yr
AP/P/2025/016652	18.07.2025	27.02.2027	2nd	yr
AP/P/2025/016653	28.07.2025	28.12.2025	1st	yr
AP/P/2025/016655	28.07.2025	11.01.2026	1st	yr
AP/P/2025/016658	28.07.2025	13.02.2021	1st	yr
AP/P/2025/016658	28.07.2025	13.02.2022	2nd	yr
AP/P/2025/016658	28.07.2025	13.02.2023	3rd	yr
AP/P/2025/016658	28.07.2025	13.02.2024	4th	yr
AP/P/2025/016658	28.07.2025	13.02.2026	6th	yr
AP/P/2025/016658	28.07.2025	13.02.2025	5th	yr
AP/P/2025/016664	28.07.2025	08.01.2026	1st	yr

## Patent Applications Lapsed/Abandoned

- (21) AP/P/2017/009814  
(23) 13.09.2019  
(51) **C01B 31/02 (2006.01)**  
**C01B 31/04 (2006.01)**  
(54) COMPOSITE CONDUCTIVE MATERIAL, POWER STORAGE DEVICE, CONDUCTIVE DISPERSION, CONDUCTIVE DEVICE, CONDUCTIVE COMPOSITE AND THERMALLY CONDUCTIVE COMPOSITE  
(71) GRAPHENE PLATFORM CORPORATION  
(72) KAMIYA Nagisa and HASEGAWA Shoji  
(74) HONEY & BLANCKENBERG  
(84) BW, GH, GM, KE, LR, LS, MW, MZ, NA, RW, SD, SL, ST, SZ, TZ, UG, ZM, ZW
- ●
- (21) AP/P/2017/010050  
(23) 28.07.2025  
(51) **A61K 31/00 (2006.01)**  
**A61K 9/20 (2006.01)**  
**A61K 9/00 (2006.01)**  
(54) DISPERSIBLE COMPOSITIONS  
(71) JANSSEN PHARMACEUTICA NV  
(72) NAIR Shreedevi Velayudhan, TAMBWEKAR Kaustubh Ramesh, MARATHE Shripad Wasudeo, et al  
(74) HONEY & BLANCKENBERG  
(84) BW, GH, GM, KE, LR, LS, MW, MZ, NA, SD, SL, ST, SZ, TZ, ZM, ZW
- ●
- (21) AP/P/2018/010847  
(23) 22.06.2019  
(51) **E04G 11/54 (2006.01)**  
**E04C 3/40 (2006.01)**  
(54) SUPPORTING FRAMEWORK  
(71) PERI GMBH  
(72) RUPP Markus  
(74) SAMURIWO ATTORNEYS  
(84) BW, GH, GM, KE, LR, LS, MW, MZ, NA, RW, SD, SL, ST, SZ, TZ, UG, ZM, ZW
- ●
- (21) AP/P/2018/011219  
(23) 08.11.2019  
(51) **C02F 1/00 (2006.01)**  
(54) MODULAR WATER PROVISION SYSTEM FOR RURAL HOUSING  
(71) Mikhol Sahar Ltd., Jerusalem (IL)  
(72) HAWAI Shalom Shay and HAVI Moshe  
(74) ISEME, KAMAU & MAEMA ADVOCATES  
(84) BW, GH, GM, KE, LR, LS, MW, MZ, NA, RW, SD, SL, ST, SZ, TZ, UG, ZM, ZW
- ●

- (21) AP/P/2019/012096  
(23) 14.12.2020  
(51) **B01J 19/18 (2006.01)**  
**B01J 8/00 (2006.01)**  
(54) METHOD FOR CREATING PARAMETRIC RESONANCE IN THE ATOMS OF CHEMICAL ELEMENTS IN A SUBSTANCE  
(71) NATURAL RESOURCE BENEFICIATION LIMITED  
(72) SELIVANOV Nikolay Ivanovich  
(74) ROLAND INTELLECTUAL PROPERTY CONSULTANTS  
(84) BW, GH, GM, KE, LR, LS, MW, MZ, NA, RW, SD, SL, ST, SZ, TZ, UG, ZM, ZW
- ●
- (21) AP/P/2020/012426  
(23) 30.05.2025  
(51) **A61K 38/17 (2006.01)**  
**C07K 16/30 (2006.01)**  
**A61K 47/68 (2017.01)**  
**C07K 16/28 (2006.01)**  
(54) HUMANIZED ANTI-LIV1 ANTIBODIES FOR THE TREATMENT OF BREAST CANCER  
(71) SEATTLE GENETICS, INC.  
(72) ABIDOYE Oyewale O, PALANCA-WESSELS Corinna, GARFIN Phillip, et al  
(74) FISHER CORMACK & BOTHA  
(84) BW, GH, GM, KE, LR, LS, MW, MZ, NA, RW, SD, SL, ST, SZ, TZ, UG, ZM, ZW
- ●
- (21) AP/P/2020/012527  
(23) 21.07.2025  
(51) **C07K 16/28 (2006.01)**  
**A61P 35/00 (2006.01)**  
**A61K 39/00 (2006.01)**  
(54) METHODS OF TREATING CANCERS WITH ANTAGONISTIC ANTI-PD-1 ANTIBODIES  
(71) JANSSEN BIOTECH, INC.  
(72) MAYER Christina Lourdes, XIE Hong, GREGER James G, et al  
(74) HONEY & BLANCKENBERG  
(84) BW, GH, GM, KE, LR, LS, MW, MZ, NA, RW, SD, SL, ST, SZ, TZ, UG, ZM, ZW
- ●
- (21) AP/P/2020/012577  
(23) 07.07.2025  
(51) **A61B 6/03 (2006.01)**  
**A61B 6/00 (2006.01)**  
(54) DIAGNOSTIC SUPPORT PROGRAM  
(71) MEDIOTT CO., LTD. and PARAMEVIA PTE. LTD.  
(72) YOSHIDA Norifumi and ABE Takehiko  
(74) FISHER CORMACK & BOTHA  
(84) BW, GH, GM, KE, LR, LS, MW, MZ, NA, RW, SD, SL, ST, SZ, TZ, UG, ZM, ZW
- ●

- (21) AP/P/2020/012776  
(23) 06.05.2023  
(51) **A01D 34/412 (2015.01)**  
**A01D 34/43 (2015.01)**  
**A01D 34/835 (2015.01)**  
**A01D 34/64 (2015.01)**  
**A01D 34/74 (2015.01)**  
**A01D 45/00 (2015.01)**  
(54) IMPROVEMENT INTRODUCED IN WOODY PLANT SUPPRESSOR  
(71) AGROTRITUS - LOCAÇÃO E COMÉRCIO DE MÁQUINAS, LTDA  
(72) RIBEIRO Manuel Pina Cabrita da Silva  
(74) MAULATE Aida Salvador  
(84) BW, GH, GM, KE, LR, LS, MW, NA, RW, SD, SL, ST, SZ, TZ, UG, ZM, ZW
- ●
- (21) AP/P/2021/013425  
(23) 29.07.2025  
(51) **F16J 15/56 (2006.01)**  
**F02G 1/053 (2006.01)**  
(54) IMPROVED ROD SEAL ASSEMBLIES FOR MACHINES  
(71) AZELIO AB  
(72) SÄÄW Olle, EDVINSSON Åke, BAUMUELLER Andreas, et al  
(74) FISHER CORMACK & BOTHA  
(84) BW, GH, GM, KE, LR, LS, MW, MZ, NA, RW, SD, SL, ST, SZ, TZ, UG, ZM, ZW
- ●
- (21) AP/P/2022/013822  
(23) 10.02.2025  
(51) **A61K 36/00 (2016.01)**  
**A01N 47/42 (2016.01)**  
**A01N 25/22 (2016.01)**  
**A01N 35/04 (2016.01)**  
**A01N 65/00 (2016.01)**  
**B32B 2439/00 (2016.01)**  
**B32B 2307/416 (2016.01)**  
**B32B 2307/304 (2016.01)**  
**A61L 9/00 (2016.01)**  
**F25D 2201/1282 (2016.01)**  
**F25D 3/06 (2016.01)**  
**B65D 65/40 (2016.01)**  
**B32B 15/04 (2016.01)**  
**B65D 81/00 (2016.01)**  
**B65D 81/38 (2016.01)**  
**B65D 81/24 (2016.01)**  
**F25D 2201/10 (2016.01)**  
(54) ATMOSPHERE CONTROLLING REFLECTIVE INSULATED CONTAINER  
(71) VALUEFORM LTD  
(72) KORDE Damodar Prakash and HEFFT Ingo Daniel  
(74) MAINA Mwangi John  
(84) GH, GM, KE, MW, NA, RW, SD, TZ, UG
- ●



## Patent Applications Lapsed/Abandoned (Contd.)

(21) AP/P/2022/013864

(23) 06.05.2025

(51) **C12N 15/86 (2006.01)**

**A61P 31/14 (2006.01)**

**C12N 7/00 (2006.01)**

**A61K 39/215 (2006.01)**

(54) EXPRESSION VECTOR AGAINST SEVERE ACUTE RESPIRATORY SYNDROME VIRUS SARS-COV-2

(71) FEDERAL STATE BUDGETARY INSTITUTION "NATIONAL RESEARCH CENTRE FOR EPIDEMIOLOGY AND MICROBIOLOGY NAMED AFTER THE HONORARY ACADEMICIAN N.F. GAMALEYA" OF THE MINISTRY OF HEALTH OF THE RUSSIAN FEDERATION

(72) GINTSBURG Aleksandr Leonidovich, LOGUNOV Denis Yuryevich, NARODITSKY Boris Savelievich, et al

(74) DAIMON CONSULTANCY SERVICES

(84) GH, UG

● ●

(21) AP/P/2022/013936

(23) 22.07.2025

(51) **H04W 4/00 (2016.01)**

**G01S 17/00 (2016.01)**

**G01C 21/00 (2016.01)**

**H04B 7/00 (2016.01)**

**G06K 9/00 (2016.01)**

**G06Q 10/00 (2016.01)**

**G07C 5/00 (2016.01)**

**G01S 7/00 (2016.01)**

**H04J 3/14 (2016.01)**

(54) A SYSTEM AND METHOD FOR GENERATING UTILIZATION DATA OF A VEHICLE

(71) MAHINDRA & MAHINDRA LIMITED

(72) SINGHA Partha Sarathi, SARAVANAN N, PUSHPARAJ Karthikesh, et al

(74) ROLAND INTELLECTUAL PROPERTY CONSULTANTS

(84) BW, GH, GM, KE, LR, LS, MW, MZ, NA, RW, SD, SL, ST, SZ, TZ, UG, ZM, ZW

● ●

(21) AP/P/2022/014043

(23) 14.07.2025

(51) **A61P 31/14 (2006.01)**

**A61K 31/7072 (2006.01)**

**A61K 31/708 (2006.01)**

**A61K 31/7088 (2006.01)**

**A61K 38/21 (2006.01)**

**A61K 31/55 (2006.01)**

**A61K 31/575 (2006.01)**

**A61K 31/675 (2006.01)**

**A61K 31/7056 (2006.01)**

**A61K 31/439 (2006.01)**

**A61K 31/4439 (2006.01)**

**A61K 31/4545 (2006.01)**

**A61K 31/496 (2006.01)**

**A61K 31/513 (2006.01)**

**A61K 31/4162 (2006.01)**

**A61K 31/42 (2006.01)**

**A61K 31/423 (2006.01)**

**A61K 31/426 (2006.01)**

**A61K 31/167 (2006.01)**

**A61K 31/397 (2006.01)**

**A61K 31/4045 (2006.01)**

(54) USE OF FXR AGONISTS FOR TREATING AN INFECTION BY HEPATITIS D VIRUS

(71) ENYO PHARMA, CENTRE NATIONAL DE LA RECHERCHE SCIENTIFIQUE, UNIVERSITE CLAUDE BERNARD LYON 1, et al

(72) ANDRE Patrice, LOTTEAU Vincent, LACOMBE Benoit, et al

(74) GALLOWAY & COMPANY

(84) BW, GH, GM, KE, LR, LS, MW, MZ, NA, RW, SD, SL, ST, SZ, TZ, UG, ZM, ZW

● ●

(21) AP/P/2022/014062

(23) 21.02.2025

(51) **A61F 6/06 (2006.01)**

(54) A FEMALE CONDOM

(71) CUPID LIMITED

(72) GARG Om Prakash

(74) CLAIRWOOD CHAMBERS

(84) GH, KE, MZ, TZ

● ●

(21) AP/P/2022/014163

(23) 08.07.2025

(51) **A24B 15/10 (2006.01)**

**A01H 6/82 (2018.01)**

**A01H 5/12 (2018.01)**

**A01H 5/04 (2018.01)**

(54) A GENETIC APPROACH FOR ACHIEVING ULTRA LOW NICOTINE CONTENT IN TOBACCO

(71) 22ND CENTURY LIMITED, LLC and NORTH CAROLINA STATE UNIVERSITY

(72) TAMBURRINO Juan Sanchez, DEWEY Ralph E and LEWIS Ramsey S

(74) ROLAND INTELLECTUAL PROPERTY CONSULTANTS

(84) BW, GH, GM, KE, LR, LS, MW, MZ, NA, RW, SD, SL, ST, SZ, TZ, UG, ZM, ZW

● ●

(21) AP/P/2022/014174

(23) 27.05.2025

(51) **A41D 13/11 (2006.01)**

**A01N 25/12 (2006.01)**

**A01N 25/08 (2006.01)**

**A62B 7/10 (2006.01)**

**A62B 23/02 (2006.01)**

**A01N 33/12 (2006.01)**

**A62B 15/00 (2006.01)**

**A61L 9/00 (2006.01)**

**B01D 37/02 (2006.01)**

(54) MANUFACTURING PROCESS OF PHOSPHATE GLASS FIBER

(71) UNIVERSITE MOHAMED VI POLYTECHNIQUE (UM6P), UNIVERSITE HASSAN II DE CASABLANCA (UH2C) and ÉCOLE SUPÉRIEURE DES INDUSTRIES DU TEXTILE ET DE L'HABILLEMENT (ESITH)

(72) CHERKAOUI Omar, TAMRAOUI Youssef, LAHLOU Mohamed Esith, et al

(74) SAMURIWO ATTORNEYS

(84) GH, KE, MZ, TZ, ZM, ZW

● ●

(21) AP/P/2022/014197

(23) 07.07.2025

(51) **C12R 1/01 (2006.01)**

**C12P 7/56 (2006.01)**

**C12N 1/22 (2006.01)**

(54) METHOD OF PRODUCING LACTIC ACID FROM MODIFIED STARCH

(71) BLUCON BIOTECH GMBH

(72) KRAMER Marco, SVETLICHNY Vitaly and SVETLICHNAYA Tatiana

(74) CLAIRWOOD CHAMBERS

(84) BW, GH, GM, KE, LR, LS, MW, MZ, NA, RW, SD, SL, ST, SZ, TZ, UG, ZM, ZW

● ●

(21) AP/P/2022/014223

(23) 22.07.2025

(51) **F16L 1/00 (2006.01)**

**E21B 17/01 (2006.01)**

**F16L 1/20 (2006.01)**

(54) SPRING

(71) BALMORAL COMTEC LIMITED

(72) LANNAGAN William Henry and MILNE Fraser James

(74) FISHER CORMACK & BOTHA

(84) GH

● ●



## Patent Applications Lapsed/Abandoned (Contd.)

- (21) AP/P/2023/015040  
(23) 14.07.2025  
(51) **C07H 15/203 (2006.01)**  
**A61P 35/00 (2006.01)**  
**A61K 31/4184 (2006.01)**  
**C07D 403/12 (2006.01)**
- (54) IMMUNOMODULATORY ANTIBODY-  
DRUG CONJUGATES
- (71) SEAGEN INC.
- (72) GARDAI Shyra J, BURKE Patrick J,  
CUMMINS Elizabeth J, et al
- (74) ROLAND INTELLECTUAL PROPERTY  
CONSULTANTS
- (84) BW, GH, GM, KE, LR, LS, MW, MZ, NA,  
RW, SC, SD, SL, ST, SZ, TZ, UG, ZM,  
ZW



- (21) AP/P/2023/015043  
(23) 24.07.2025  
(51) **C07K 16/28 (2006.01)**  
**A61P 35/00 (2006.01)**  
**C07K 16/30 (2006.01)**
- (54) PSMA BINDING PROTEINS AND USES  
THEREOF
- (71) JANSSEN BIOTECH, INC.
- (72) HERTZOG Jennifer, BRODEUR Scott R,  
YANG Danlin, et al
- (74) HONEY & BLANCKENBERG
- (84) BW, GH, GM, KE, LR, LS, MW, MZ, NA,  
RW, SC, SD, SL, ST, SZ, TZ, UG, ZM,  
ZW



- (21) AP/P/2024/016036  
(23) 26.05.2025  
(51) **A61Q 11/00 (2006.01)**  
**A61K 8/27 (2006.01)**  
**A61K 8/34 (2006.01)**  
**A61K 8/21 (2006.01)**  
**A61K 8/25 (2006.01)**  
**A61Q 17/00 (2006.01)**
- (54) ORAL CARE COMPOSITION
- (71) UNILEVER GLOBAL IP LIMITED
- (72) TOPI Francesca, SAVOCA Michela and  
CAMPI Gianni
- (74) SPOOR.FISHER
- (84) GH



- (21) AP/P/2024/016086  
(23) 05.05.2025  
(51) **A61P 31/14 (2006.01)**  
**C07D 417/14 (2006.01)**

**A61K 31/4439 (2006.01)**  
**C07D 401/14 (2006.01)**  
**C07D 413/14 (2006.01)**

- (54) INHIBITORS OF HUMAN  
RESPIRATORY SYNCYTIAL VIRUS  
AND METAPNEUMOVIRUS
- (71) MERCK SHARP & DOHME LLC
- (72) YAZDANI Mahdieh, SCHLEGEL Kelly  
Ann S, MANLEY Peter J, et al
- (74) ADAMS AND ADAMS MOZAMBIQUE
- (84) BW, GH, KE, NA, SC



## Patents and Patent Applications Restored

- (11) AP 4816  
(22) 21.05.2013  
(23) 06.06.2019  
(31) UZ2012 0233  
(32) 18.06.2012 (33) UZ
- (51) **C12Q 1/04 (2006.01)**  
**G01N 33/569 (2006.01)**  
**G01N 33/483 (2006.01)**  
**C12Q 1/68 (2006.01)**
- (54) METHOD FOR ASSESSING THE  
VIABILITY OF VIRUSES WITH  
LYMPHOTROPISM
- (71) MKRTCHYAN Leonardovich Ovik
- (72) GULYAMOV Nariman
- (74) ROLAND INTELLECTUAL PROPERTY  
CONSULTANTS
- (84) BW, GM, GH, KE, LS, LR, MW, MZ, NA,  
RW, SL, SD, SZ, TZ, UG, ZM, ZW
- (86) 21.05.2013 PCT/UZ13/000001
- (96) 21.05.2013 AP/P/2014/008052



- (21) AP/P/2021/013196  
(22) 17.10.2019  
(23) 14.05.2021  
(31) 2018/06915  
(32) 17.10.2018 (33) ZA
- (51) **B65D 88/52 (2006.01)**
- (54) A TRANSPORT CONTAINER
- (74) SAMURIWO ATTORNEYS
- (75) JAMES Christopher Colin
- (84) BW, GH, KE, LS, MW, MZ, NA, SZ, ZM,  
ZW
- (86) 17.10.2019 PCT/IB2019/058878
- (96) 17.10.2019 AP/P/2021/013196



- (21) AP/P/2024/016177  
(22) 07.04.2023  
(23) 13.12.2024  
(31) 202241027681  
(32) 13.05.2022 (33) IN
- (51) **A61K 47/00 (2006.01)**
- (54) POLYMERIC GEL-BASED  
AGROBIOLOGICAL COMPOSITION
- (71) FIB-SOL LIFE TECHNOLOGIES PVT.  
LTD.
- (72) RAJASHEKHAR Bijja, BISWA Pramal  
and SAIRAM Kavitha
- (74) ABDULLAHI Abuzaid Mohammed  
Ammar
- (84) GH, KE, MW, TZ, UG, ZM
- (96) 07.04.2023 AP/P/2024/016177



## Patent Applications Pending Grant

(21) AP/P/2017/009928

(22) 12.11.2015

(23) 25.07.2025

(51) **E21B 47/00 (2006.01)****E21B 10/00 (2006.01)****E21B 47/12 (2006.01)**

(54) APPARATUS AND METHOD FOR MEASURING DRILLING PARAMETERS OF A DOWN - THE -HOLE DRILLING OPERATION FOR MINERAL EXPLORATION

(74) GALLOWAY &amp; COMPANY

(84) BW, GH, GM, KE, LR, LS, MW, MZ, NA, RW, SD, SL, ST, SZ, TZ, UG, ZM, ZW

● ●

(21) AP/P/2019/011723

(22) 02.02.2018

(23) 11.01.2024

(51) **A61K 31/498 (2006.01)****G01N 33/574 (2006.01)****A61P 35/00 (2006.01)**

(54) CANCER TREATMENT

(74) HONEY &amp; BLANCKENBERG

(84) BW, GH, GM, KE, LR, LS, MW, MZ, NA, SD, SL, ST, SZ, TZ, UG, ZM, ZW

● ●

(21) AP/P/2020/012430

(22) 13.11.2018

(23) 07.07.2025

(51) **H04B 7/0456 (2017.01)****H04L 5/00 (2006.01)****H04B 7/06 (2006.01)****H04L 1/00 (2006.01)**

(54) METHODS AND APPARATUSES FOR PORT INDEX SIGNALING FOR NON-PRECODER MATRIX INDICATOR (PMI) CHANNEL STATE INFORMATION (CSI) FEEDBACK

(74) ROLAND INTELLECTUAL PROPERTY CONSULTANTS

(84) KE

● ●

(21) AP/P/2020/012474

(22) 10.03.2016

(23) 21.07.2025

(51) **G10L 21/038 (2013.01)****G10L 19/035 (2013.01)****G10L 19/16 (2013.01)****G10L 19/24 (2013.01)**

(54) DECODING AUDIO BITSTREAMS WITH ENHANCED SPECTRAL BAND REPLICATION METADATA IN AT LEAST ONE FILL ELEMENT

(74) FISHER CORMACK &amp; BOTHA

(84) BW, GH, GM, KE, LR, LS, MW, MZ, NA, RW, SD, SL, ST, SZ, TZ, UG, ZM, ZW

● ●

(21) AP/P/2020/012611

(22) 10.03.2016

(23) 22.07.2025

(51) **G10L 19/00 (2013.01)**

(54) DECODING AUDIO BITSTREAMS WITH ENHANCED SPECTRAL BAND REPLICATION METADATA IN AT LEAST ONE FILL ELEMENT

(74) FISHER CORMACK &amp; BOTHA

(84) BW, GH, GM, KE, LR, LS, MW, MZ, NA, RW, SD, SL, ST, SZ, TZ, UG, ZM, ZW

● ●

(21) AP/P/2021/013003

(22) 31.07.2019

(23) 23.07.2025

(51) **C12N 15/63 (2006.01)****C12N 15/86 (2006.01)****A61P 25/00 (2006.01)****C12N 15/09 (2006.01)****C12N 15/12 (2006.01)**

(54) GENE THERAPY METHODS TO CONTROL ORGAN FUNCTION

(74) ADAMS AND ADAMS MOZAMBIQUE

(84) BW, GH, GM, KE, LR, LS, MW, MZ, NA, SD, SL, ST, SZ, TZ, ZM, ZW

● ●

(21) AP/P/2021/013157

(22) 04.10.2019

(23) 03.07.2025

(51) **A61K 36/37 (2006.01)****A61K 9/68 (2006.01)**

(54) CHEWING GUM COMPOSITIONS COMPRISING KHAT OR KHAT BASED ALKALOID STIMULANTS

(74) ADAMS AND ADAMS MOZAMBIQUE

(84) KE, UG

● ●

(21) AP/P/2021/013460

(22) 31.08.2021

(23) 22.07.2025

(51) **G06F 3/00 (2006.01)**

(54) PROCESSING METHOD, ELECTRONIC DEVICE AND READABLE STORAGE MEDIUM

(74) ROLAND INTELLECTUAL PROPERTY CONSULTANTS

(84) KE

● ●

(21) AP/P/2021/013550

(22) 13.03.2020

(23) 03.07.2025

(51) **C08L 89/00 (2006.01)**

(54) PROCESS OF MANUFACTURING BIODEGRADABLE PET CHIPS

(74) B MATANGA IP ATTORNEYS

(84) GH, KE

● ●

(21) AP/P/2021/013552

(22) 24.03.2020

(23) 02.07.2025

(51) **A61K 39/395 (2006.01)****A61K 45/06 (2006.01)****A61P 35/00 (2006.01)****C12N 9/26 (2006.01)****A61K 9/00 (2006.01)****A61K 47/42 (2006.01)**

(54) PHARMACEUTICAL COMPOSITION, COMPRISING HUMAN HYALURONIDASE PH20 VARIANT AND DRUG, FOR SUBCUTANEOUS INJECTION

(74) HONEY &amp; BLANCKENBERG

(84) BW, GH, KE, NA

● ●

(21) AP/P/2021/013593

(22) 20.05.2020

(23) 15.07.2025

(51) **G01N 33/574 (2006.01)****G01N 33/558 (2006.01)**

(54) METHODS OF DIAGNOSING AND TREATING CERVICAL CANCER

(74) FISHER CORMACK &amp; BOTHA

(84) BW, GH, GM, KE, LR, LS, MW, MZ, NA, RW, SD, SL, ST, SZ, TZ, UG, ZM, ZW

● ●

(21) AP/P/2021/013631

(22) 05.03.2020

(23) 03.07.2025

(51) **C12Q 1/689 (2018.01)****C12Q 1/6883 (2018.01)**

(54) METHODS RELATING TO TUBERCULOSIS

(74) ADAMS AND ADAMS MOZAMBIQUE

(84) BW, GH, GM, KE, LR, LS, MW, MZ, NA, RW, SD, SL, ST, SZ, TZ, UG, ZM, ZW

● ●

(21) AP/P/2021/013654

(22) 21.07.2020

(23) 02.07.2025

(51) **C04B 5/06 (2006.01)****B09B 3/00 (2006.01)****C03C 1/02 (2006.01)**

(54) METHOD AND SYSTEM FOR SLAG VITRIFICATION OF TOXIC ELEMENTS

(74) Cronjé &amp; Co.

(84) GH

● ●



## Patent Applications Pending Grant (Contd.)

- (21) AP/P/2022/014003  
(22) 30.10.2020  
(23) 09.07.2025  
(51) **B28B 7/24 (2006.01)**  
**B28B 7/08 (2006.01)**  
(54) FORMWORK DEVICE  
(74) ADAMS AND ADAMS MOZAMBIQUE  
(84) GH, KE, RW

● ●

- (21) AP/P/2022/014010  
(22) 08.06.2020  
(23) 18.07.2025  
(51) **F01N 3/20 (2006.01)**  
**B01J 35/04 (2006.01)**  
**F01N 3/021 (2006.01)**  
**F01N 3/10 (2006.01)**  
**B01D 53/86 (2006.01)**  
**B01D 53/94 (2006.01)**  
**B01J 35/02 (2006.01)**  
(54) EXHAUST SYSTEM AND FEATURES THEREOF  
(74) ADAMS AND ADAMS MOZAMBIQUE  
(84) SD

● ●

- (21) AP/P/2022/014053  
(22) 28.10.2020  
(23) 15.07.2025  
(51) **B09B 3/00 (2006.01)**  
**C10L 5/44 (2006.01)**  
**C05F 11/00 (2006.01)**  
(54) PLANT PROCESSING METHOD AND PLANT PROCESSING SYSTEM  
(74) FISHER CORMACK & BOTHA  
(84) KE, TZ, UG

● ●

- (21) AP/P/2022/014080  
(22) 23.12.2020  
(23) 08.07.2025  
(51) **G01N 27/04 (2006.01)**  
**G06Q 10/06 (2012.01)**  
**G01N 33/24 (2006.01)**  
**G01V 1/00 (2006.01)**  
**G01V 3/15 (2006.01)**  
**G01N 24/08 (2006.01)**  
**G01R 33/00 (2006.01)**  
**G01R 33/38 (2006.01)**  
**G01R 33/42 (2006.01)**  
**B07C 5/34 (2006.01)**  
**G01S 1/70 (2006.01)**  
(54) AN APPARATUS FOR THE MEASUREMENT OF ORE IN MINE HAUL VEHICLES

- (74) ADAMS AND ADAMS MOZAMBIQUE  
(84) BW, GH, GM, KE, LR, LS, MW, MZ, NA, RW, SD, SL, ST, SZ, TZ, UG, ZM, ZW

● ●

- (21) AP/P/2022/014135  
(22) 23.11.2020  
(23) 17.07.2025  
(51) **B32B 27/00 (2006.01)**  
**B32B 17/02 (2006.01)**  
**B32B 15/02 (2006.01)**  
(54) A COMPOSITE PANEL  
(74) GALLOWAY & COMPANY  
(84) BW, LS, MW, MZ, NA, SZ, ZM, ZW

● ●

- (21) AP/P/2022/014148  
(22) 17.11.2020  
(23) 24.07.2025  
(51) **A61M 5/32 (2006.01)**  
**B02C 21/02 (2006.01)**  
**A61L 11/00 (2006.01)**  
**B02C 7/06 (2006.01)**  
**B02C 7/00 (2006.01)**  
**B02C 18/22 (2006.01)**  
(54) WASTE DESTRUCTION DEVICE FOR SHARPS, NEEDLES AND SOLID WASTE  
(74) ADAMS AND ADAMS MOZAMBIQUE  
(84) GM, KE, RW, SL, UG, ZM, ZW

● ●

- (21) AP/P/2022/014278  
(22) 18.03.2021  
(23) 25.07.2025  
(51) **C07D 413/04 (2006.01)**  
**C07D 471/04 (2006.01)**  
**C07D 487/04 (2006.01)**  
**A61K 31/44 (2006.01)**  
**C07D 311/58 (2006.01)**  
**C07D 401/04 (2006.01)**  
**C07D 409/04 (2006.01)**  
**C07D 277/62 (2006.01)**  
**C07D 307/83 (2006.01)**  
**C07D 307/88 (2006.01)**  
**C07D 277/24 (2006.01)**  
**C07D 277/40 (2006.01)**  
**C07D 277/56 (2006.01)**  
**C07D 263/56 (2006.01)**  
**C07D 265/36 (2006.01)**  
**C07D 249/06 (2006.01)**  
**C07D 249/08 (2006.01)**  
**C07D 263/32 (2006.01)**  
**C07D 239/42 (2006.01)**  
**C07D 241/12 (2006.01)**  
**C07D 241/20 (2006.01)**  
**C07D 231/56 (2006.01)**  
**C07D 237/20 (2006.01)**  
**C07D 239/28 (2006.01)**  
**C07D 217/02 (2006.01)**  
**C07D 231/12 (2006.01)**  
**C07D 231/14 (2006.01)**

- C07D 215/18 (2006.01)**  
**C07D 215/36 (2006.01)**  
**C07D 215/48 (2006.01)**  
**C07D 213/74 (2006.01)**  
**C07D 213/84 (2006.01)**  
**C07D 213/64 (2006.01)**  
**C07D 213/71 (2006.01)**  
**C07D 213/73 (2006.01)**  
**A61P 35/00 (2006.01)**  
**C07D 213/30 (2006.01)**  
**C07D 213/61 (2006.01)**  
**C07C 317/22 (2006.01)**  
**C07D 209/34 (2006.01)**  
**C07D 213/26 (2006.01)**  
**C07C 255/52 (2006.01)**  
**C07C 317/14 (2006.01)**

- (54) TETRALIN AND TETRAHYDROQUINOLINE COMPOUNDS AS INHIBITORS OF HIF-2ALPHA  
(74) B. W. KAHARI LEGAL PRACTITIONERS  
(84) BW, GH, GM, KE, LR, LS, MW, MZ, NA, RW, SD, SL, ST, SZ, TZ, UG, ZM, ZW

● ●

- (21) AP/P/2022/014293  
(22) 05.03.2021  
(23) 23.07.2025  
(51) **C22B 3/44 (2006.01)**  
**C22B 60/02 (2006.01)**  
**C22B 3/06 (2006.01)**  
**C22B 3/22 (2006.01)**  
**C22B 59/00 (2006.01)**

- (54) METHOD FOR SELECTIVE SEPARATION OF THORIUM AND CERIUM FROM A SOLID CONCENTRATE COMPRISING SAME AND ONE OR MORE FURTHER RARE EARTH METALS AND ACIDIC RARE EARTH SOLUTION THEREOF  
(74) INVENTA MOZAMBIQUE, LDA.  
(84) TZ

● ●

- (21) AP/P/2022/014388  
(22) 23.03.2021  
(23) 29.07.2025  
(51) **F01K 3/18 (2006.01)**  
**F01K 25/10 (2006.01)**  
(54) PLANT AND PROCESS FOR ENERGY GENERATION AND STORAGE  
(74) FISHER CORMACK & BOTHA  
(84) BW, GH, GM, KE, LR, LS, MW, MZ, NA, RW, SD, SL, ST, SZ, TZ, UG, ZM, ZW

● ●



## Patent Applications Pending Grant (Contd.)

(21) AP/P/2022/014390  
(22) 25.06.2021  
(23) 11.07.2025  
(51) **A61K 31/54 (2006.01)**  
**A61K 31/5365 (2006.01)**  
**A61K 31/519 (2006.01)**  
(54) TETRAZOLE DERIVATIVES AS TRPA1 INHIBITORS  
(74) Cronjé & Co.  
(84) GH, KE

● ●

(21) AP/P/2022/014453  
(22) 10.05.2021  
(23) 08.07.2025  
(51) **B28B 7/00 (2006.01)**  
**E03B 11/00 (2006.01)**  
**E03F 1/00 (2006.01)**  
(54) UNDERGROUND TANK SYSTEM AND METHOD OF MANUFACTURING AN UNDERGROUND TANK SYSTEM  
(74) ENSafrica Namibia  
(84) BW, GH, KE, LS, MW, MZ, NA, RW, UG, ZM, ZW

● ●

(21) AP/P/2022/014478  
(22) 21.05.2021  
(23) 28.07.2025  
(51) **H04N 19/70 (2014.01)**  
**H04N 19/503 (2014.01)**  
(54) VIDEO ENCODER, VIDEO DECODER, METHODS FOR ENCODING AND DECODING AND VIDEO DATA STREAM FOR REALIZING ADVANCED VIDEO CODING CONCEPTS  
(74) GALLOWAY & COMPANY  
(84) BW, GH, GM, KE, LR, LS, MW, MZ, NA, RW, SD, SL, ST, SZ, TZ, UG, ZM, ZW

● ●

(21) AP/P/2022/014502  
(22) 15.12.2020  
(23) 01.07.2025  
(51) **G06F 16/903 (2019.01)**  
(54) QUICK SEARCH METHOD, TERMINAL AND STORAGE MEDIUM  
(74) INVENTA MOZAMBIQUE, LDA.  
(84) KE

● ●

(21) AP/P/2022/014533  
(22) 04.05.2021  
(23) 11.07.2025

(51) **G01N 33/543 (2006.01)**  
**G01N 33/569 (2006.01)**  
**B01L 3/00 (2006.01)**  
(54) A DIAGNOSTIC DEVICE  
(74) ROLAND INTELLECTUAL PROPERTY CONSULTANTS  
(84) BW, GH, GM, KE, LR, MW, NA, SD, ST, TZ, UG

● ●

(21) AP/P/2023/014636  
(22) 18.06.2020  
(23) 18.07.2025  
(51) **C01B 17/765 (2006.01)**  
**C01B 17/80 (2006.01)**  
(54) PROCESS AND PLANT FOR THE PRODUCTION OF SULFURIC ACID  
(74) FISHER CORMACK & BOTHA  
(84) BW, GH, GM, KE, LR, LS, MW, MZ, NA, RW, SD, SL, ST, SZ, TZ, UG, ZM, ZW

● ●

(21) AP/P/2023/014657  
(22) 05.06.2020  
(23) 09.07.2025  
(51) **B64D 1/12 (2006.01)**  
**B64D 1/22 (2006.01)**  
**B64C 39/02 (2006.01)**  
**B64D 5/00 (2006.01)**  
**B64D 1/00 (2006.01)**  
**B64D 3/00 (2006.01)**  
(54) SUSPENDED AERIAL VEHICLE SYSTEM WITH THRUSTER STABILIZATION  
(74) B. W. KAHARI LEGAL PRACTITIONERS  
(84) GH, RW

● ●

(21) AP/P/2023/014735  
(22) 26.04.2022  
(23) 24.07.2025  
(51) **G06Q 20/08 (2012.01)**  
**G06Q 20/04 (2012.01)**  
**G06Q 20/06 (2012.01)**  
(54) SYSTEM AND METHOD FOR CONDUCTING A TRANSACTION  
(74) ROLAND INTELLECTUAL PROPERTY CONSULTANTS  
(84) GH, UG, ZM

● ●

(21) AP/P/2023/014738  
(22) 18.08.2021  
(23) 16.07.2025  
(51) **A61B 5/15 (2006.01)**  
**A61B 5/151 (2006.01)**  
**A61B 5/155 (2006.01)**  
(54) FINGER RECEPTACLE AND HOLDING DEVICE  
(74) FISHER CORMACK & BOTHA  
(84) BW, GH, GM, KE, LR, LS, MW, MZ, NA, RW, SD, SL, ST, SZ, TZ, UG, ZM, ZW

● ●

(21) AP/P/2023/014814  
(22) 25.04.2019  
(23) 03.07.2025  
(51) **G10L 21/0388 (2013.01)**  
**G10L 19/02 (2013.01)**  
**G10L 19/24 (2013.01)**  
(54) INTEGRATION OF HIGH FREQUENCY AUDIO RECONSTRUCTION TECHNIQUES  
(74) FISHER CORMACK & BOTHA  
(84) BW, GH, GM, KE, LR, LS, MW, MZ, NA, RW, SD, SL, ST, SZ, TZ, UG, ZM, ZW

● ●

(21) AP/P/2023/014821  
(22) 20.10.2021  
(23) 10.07.2025  
(51) **B28B 13/02 (2006.01)**  
**B29C 39/04 (2006.01)**  
**B28B 7/00 (2006.01)**  
**B28B 7/18 (2006.01)**  
(54) CONSTRUCTION APPARATUSES AND METHODS OF USE THEREOF  
(74) FISHER CORMACK & BOTHA  
(84) GH, KE, LS, MZ, RW, SL, SZ, TZ, UG, ZW

● ●

(21) AP/P/2023/014845  
(22) 10.12.2021  
(23) 25.07.2025  
(51) **A61P 31/12 (2006.01)**  
**A61K 36/48 (2006.01)**  
**A61K 36/53 (2006.01)**  
(54) HERBAL COMPOSITION, METHOD FOR PREPARING SAME AND METHOD FOR PREVENTING OR TREATING VIRAL INFECTIONS BY ADMINISTERING THE SAME  
(74) ROLAND INTELLECTUAL PROPERTY CONSULTANTS  
(84) MZ

● ●

(21) AP/P/2023/015146  
(22) 29.05.2020  
(23) 18.07.2025  
(51) **C07J 51/00 (2006.01)**  
**C07J 71/00 (2006.01)**  
**C07J 17/00 (2006.01)**  
**C07J 21/00 (2006.01)**  
**C07J 31/00 (2006.01)**  
**C07J 41/00 (2006.01)**  
**C07J 7/00 (2006.01)**  
**C07J 9/00 (2006.01)**  
**C07J 11/00 (2006.01)**



## Patent Applications Pending Grant (Contd.)

**C07J 13/00 (2006.01)**

**A61P 25/00 (2006.01)**

**C07J 1/00 (2006.01)**

**C07J 5/00 (2006.01)**

**C07J 43/00 (2006.01)**

**A61K 31/58 (2006.01)**

(54) NEUROACTIVE STEROIDS AND COMPOSITIONS THEREOF

(74) SPOOR.FISHER

(84) BW, GH, GM, KE, LR, LS, MW, MZ, NA, RW, SD, SL, ST, SZ, TZ, UG, ZM, ZW

● ●

(21) AP/P/2023/015165

(22) 18.03.2022

(23) 04.07.2025

(51) **A01P 5/00 (2006.01)**

**A01N 25/00 (2006.01)**

**A01N 25/04 (2006.01)**

**A01N 25/30 (2006.01)**

**A01P 3/00 (2006.01)**

**A01N 43/40 (2006.01)**

(54) CYCLOBUTRIFLURAM SUSPENSION CONCENTRATE COMPOSITION

(74) ADAMS AND ADAMS MOZAMBIQUE

(84) BW, GH, GM, KE, LR, LS, MW, MZ, NA, RW, SC, SD, SL, ST, SZ, TZ, UG, ZM, ZW

● ●

(21) AP/P/2023/015199

(22) 01.04.2021

(23) 31.07.2025

(51) **H04W 72/12 (2009.01)**

(54) CONTROLLING OF QUALITY OF EXPERIENCE MEASUREMENT

(74) GALLOWAY & COMPANY

(84) KE

● ●

(21) AP/P/2023/015365

(22) 13.02.2019

(23) 29.07.2025

(51) **H04N 19/85 (2014.01)**

**H04N 19/147 (2014.01)**

**H04N 19/46 (2014.01)**

**H04N 19/107 (2014.01)**

**H04N 19/117 (2014.01)**

**H04N 19/82 (2014.01)**

**H04N 19/503 (2014.01)**

**H04N 19/159 (2014.01)**

**H04N 19/176 (2014.01)**

(54) IMAGE RESHAPING IN VIDEO CODING USING RATE DISTORTION OPTIMIZATION

(74) SPOOR.FISHER

(84) BW, GH, GM, KE, LR, LS, MW, MZ, NA, RW, SD, SL, ST, SZ, TZ, UG, ZM, ZW

● ●

(21) AP/P/2024/015456

(22) 16.04.2021

(23) 25.07.2025

(51) **H05K 7/00 (2006.01)**

**H05K 7/14 (2006.01)**

**F24F 1/00 (2019.01)**

**F24F 1/60 (2011.01)**

**F24F 1/68 (2011.01)**

**H05K 7/20 (2006.01)**

(54) HEAT REMOVAL SYSTEMS AND METHODS

(74) SPOOR.FISHER

(84) GH, KE, TZ

● ●

(21) AP/P/2024/015561

(22) 27.12.2020

(23) 22.07.2025

(51) **A61B 42/40 (2016.01)**

**A61B 42/10 (2016.01)**

**B65G 47/90 (2006.01)**

**B65G 47/00 (2006.01)**

**A61B 42/50 (2016.01)**

**A61B 42/00 (2016.01)**

(54) APPARATUS FOR PUTTING A GLOVE ON A PALM HAND

(74) Cronjé & Co.

(84) GH, KE, MW, MZ, SD, TZ, UG, ZM, ZW

● ●

(21) AP/P/2024/015640

(22) 09.09.2022

(23) 03.07.2025

(51) **H01M 4/58 (2010.01)**

**H01M 10/0525 (2010.01)**

**C01B 25/45 (2006.01)**

(54) NOVEL GREEN LITHIUM IRON PHOSPHATE PRECURSOR, PREPARATION METHOD THEREFOR AND APPLICATION THEREOF

(74) SPOOR.FISHER

(84) BW, GH, KE, LR, MZ, NA, RW, SD, UG, ZM, ZW

● ●

(21) AP/P/2024/015675

(22) 13.02.2019

(23) 02.07.2025

(51) **H04N 19/147 (2014.01)**

**H04N 19/82 (2014.01)**

**H04N 19/85 (2014.01)**

**H04N 19/107 (2014.01)**

**H04N 19/117 (2014.01)**

**H04N 19/159 (2014.01)**

**H04N 19/176 (2014.01)**

**H04N 19/46 (2014.01)**

**H04N 19/503 (2014.01)**

(54) IMAGE RESHAPING IN VIDEO CODING USING RATE DISTORTION OPTIMIZATION

(74) SPOOR.FISHER

(84) BW, GH, GM, KE, LR, LS, MW, MZ, NA, RW, SD, SL, ST, SZ, TZ, UG, ZM, ZW

● ●

(21) AP/P/2024/015784

(22) 15.12.2022

(23) 02.07.2025

(51) **G21H 1/06 (2006.01)**

**G21H 1/10 (2006.01)**

**H01L 31/041 (2014.01)**

(54) ELECTRICAL GENERATOR SYSTEM

(74) SAMURIWO ATTORNEYS

(84) BW, CV, GH, GM, KE, LR, LS, MW, MZ, NA, RW, SC, SD, SL, ST, SZ, TZ, UG, ZM, ZW

● ●

(21) AP/P/2024/015903

(22) 15.02.2023

(23) 03.07.2025

(51) **H01M 50/509 (2021.01)**

**H01M 50/514 (2021.01)**

**B60L 58/18 (2019.01)**

**H01M 50/50 (2021.01)**

**B60L 58/21 (2019.01)**

(54) MODULAR BATTERY SYSTEM

(74) GALLOWAY & COMPANY

(84) BW, CV, GH, GM, KE, LR, LS, MW, MZ, NA, RW, SC, SD, SL, ST, SZ, TZ, UG, ZM, ZW

● ●

(21) AP/P/2024/015933

(22) 13.03.2023

(23) 04.07.2025

(51) **G09B 23/28 (2006.01)**

**G01N 33/15 (2006.01)**

**G01N 17/00 (2006.01)**

**A61K 6/20 (2020.01)**

(54) METHOD FOR DEMONSTRATING EFFICACY OF ORAL CARE PRODUCT

(74) SPOOR.FISHER

(84) GH

● ●



## Patent Applications Pending Grant (Contd.)

- (21) AP/P/2024/015945  
(22) 09.06.2023  
(23) 24.07.2025  
(51) **H02J 15/00 (2006.01)**  
**H02S 10/20 (2014.01)**
- (54) METHOD - INCLUDING ENERGY STORAGE METHOD - FOR SUPPLYING ENERGY IN THE VICINITY OF THE POINT OF CONSUMPTION USING REGENERATIVE ENERGY SOURCES, AND USE THEREOF
- (74) Becky and Tsilo Agency Private Business Corporation
- (84) BW, CV, GH, GM, KE, LR, LS, MW, MZ, NA, RW, SC, SD, SL, ST, SZ, TZ, UG, ZM, ZW
- ●
- (21) AP/P/2024/015949  
(22) 17.02.2023  
(23) 11.07.2025  
(51) **A47K 17/00 (2006.01)**  
**A47K 11/06 (2006.01)**  
**A47K 11/02 (2006.01)**  
**A47K 11/04 (2006.01)**
- (54) NOVEL TOILET
- (74) GALLOWAY & COMPANY
- (84) BW, CV, GH, GM, KE, LR, LS, MW, MZ, NA, RW, SC, SD, SL, ST, SZ, TZ, UG, ZM, ZW
- ●
- (21) AP/P/2024/015968  
(22) 07.10.2016  
(23) 08.07.2025  
(51) **G10L 19/008 (2013.01)**
- (54) LAYERED CODING AND DATA STRUCTURE FOR COMPRESSED HIGHER-ORDER AMBISONICS SOUND OR SOUND FIELD REPRESENTATIONS
- (74) SPOOR.FISHER
- (84) BW, GH, GM, KE, LR, LS, MW, MZ, NA, RW, SD, SL, ST, SZ, TZ, UG, ZM, ZW
- ●
- (21) AP/P/2024/015999  
(22) 14.03.2023  
(23) 31.07.2025  
(51) **A41G 3/00 (2006.01)**  
**D05C 15/02 (2006.01)**
- (54) AUTOMATIC HAIR TRANSPLANT DEVICE
- (74) ROLAND INTELLECTUAL PROPERTY CONSULTANTS
- (84) GH, KE, MZ, TZ
- ●

- (21) AP/P/2025/016542  
(22) 22.11.2023  
(23) 09.07.2025  
(51) **B01J 251/60 (2006.01)**  
**C07D 251/60 (2006.01)**  
**B01J 3/00 (2006.01)**  
**C07D 251/60 (2006.01)**  
**C07C 273/12 (2006.01)**
- (54) COUPLED UREA MELAMINE PRODUCTION WITH HP CO<sub>2</sub> STRIPPING
- (74) HONEY & BLANCKENBERG
- (84) GH, KE, MZ, TZ

● ●

- (21) AP/P/2025/016553  
(22) 22.11.2023  
(23) 04.07.2025  
(51) **C07C 273/16 (2006.01)**  
**C07C 273/12 (2006.01)**  
**B01J 19/00 (2006.01)**  
**C07C 273/04 (2006.01)**  
**C07D 251/60 (2006.01)**
- (54) MULTIPRODUCT LOW BIURET UREA PRODUCTION
- (74) HONEY & BLANCKENBERG
- (84) GH, KE, MZ, TZ

● ●

■

## Patents Granted

FORM 25	(12) PATENT	(19) AP																					
<p><b>(11) Patent No :</b> AP 7820</p> <p><b>(21) Application No :</b> AP/P/2023/014895</p> <p><b>(22) Filing Date :</b> 17.11.2021</p> <p><b>(24) Date of Grant &amp; (45) Publication :</b> 07/07/2025</p>	<p><b>(73) Applicant(s)</b> INSECTUM APS, c/o David Munk-Bogballe Fastrupvej 5 Fastrup 8830 Tjele, Denmark</p>																						
<p><b>(30) Priority Data</b></p> <table style="width: 100%; border-collapse: collapse;"> <thead> <tr> <th style="text-align: left;">(33) Country</th> <th style="text-align: left;">(31) Number</th> <th style="text-align: left;">(32) Date</th> </tr> </thead> <tbody> <tr> <td>EP</td> <td>20209217.7</td> <td>23.11.2020</td> </tr> </tbody> </table>	(33) Country	(31) Number	(32) Date	EP	20209217.7	23.11.2020	<p><b>(72) Inventors</b> MUNK-BOGBALLE David, Denmark</p>																
(33) Country	(31) Number	(32) Date																					
EP	20209217.7	23.11.2020																					
<p><b>(84) Designated States:</b></p> <table style="width: 100%; border-collapse: collapse;"> <tbody> <tr> <td>BW</td><td>GH</td><td>GM</td><td>KE</td><td>LR</td><td>LS</td><td>MW</td> </tr> <tr> <td>MZ</td><td>NA</td><td>RW</td><td>SD</td><td>SL</td><td>ST</td><td>SZ</td> </tr> <tr> <td>TZ</td><td>UG</td><td>ZM</td><td>ZW</td><td></td><td></td><td></td> </tr> </tbody> </table>	BW	GH	GM	KE	LR	LS	MW	MZ	NA	RW	SD	SL	ST	SZ	TZ	UG	ZM	ZW				<p><b>(74) Representative</b> FISHER CORMACK &amp; BOTHA, Malawi</p>	
BW	GH	GM	KE	LR	LS	MW																	
MZ	NA	RW	SD	SL	ST	SZ																	
TZ	UG	ZM	ZW																				

**(51) International Classification :** A01K 67/033 (2006.01)

**(54) Title**  
APPARATUS AND METHOD FOR INSECT BREEDING

**(57) Abstract**

The invention relates to an apparatus (100) and method for breeding insects, preferably larvae, and/or hatching insect eggs. The apparatus comprising: a housing (110) adapted to comprise a mass of insects and/or insect eggs and nourishment, at least one beam (120) being moveably mounted on the upper part and/or substantially in the centre of the housing, at least one substantially vertically oriented auger (130) suspended from the beam, the auger being rotatable and adapted to stir the mass of insects and nourishment in the housing, a perforated floor (140), and an air supply (150) providing an airflow through the perforated floor into the housing.

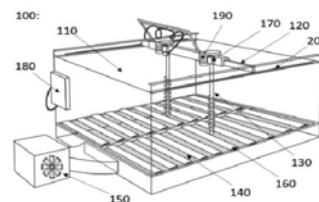

FIG. 1a

**(56) Documents Cited :** CN 203 754 620 U

US 2011/132278 A1

## Patents Granted (Contd.)

FORM 25	(12) PATENT	(19) AP																					
<p><b>(11) Patent No :</b> AP 7821</p> <p><b>(21) Application No :</b> AP/P/2023/015145</p> <p><b>(22) Filing Date :</b> 15.03.2022</p> <p><b>(24) Date of Grant &amp; (45) Publication :</b> 08/07/2025</p>	<p><b>(73) Applicant(s)</b>                      AUSTRALIAN NATURAL CAPITAL (IP) PTY LTD, c/- GPO 1920, Brisbane Queensland 4001, Australia</p>	<p><b>(72) Inventors</b>                      LODGE Benjamin Joe, Australia</p>																					
<p><b>(30) Priority Data</b></p> <table border="1" style="width: 100%; border-collapse: collapse;"> <thead> <tr> <th style="width: 15%;">(33) Country</th> <th style="width: 25%;">(31) Number</th> <th style="width: 20%;">(32) Date</th> </tr> </thead> <tbody> <tr> <td>AU</td> <td>2021900744</td> <td>15.03.2021</td> </tr> <tr> <td>AU</td> <td>2021221611</td> <td>25.08.2021</td> </tr> </tbody> </table>	(33) Country	(31) Number	(32) Date	AU	2021900744	15.03.2021	AU	2021221611	25.08.2021	<p><b>(74) Representative</b>                      ROLAND INTELLECTUAL PROPERTY CONSULTANTS, Namibia</p>													
(33) Country	(31) Number	(32) Date																					
AU	2021900744	15.03.2021																					
AU	2021221611	25.08.2021																					
<p><b>(84) Designated States:</b></p> <table style="width: 100%; text-align: center;"> <tr> <td>BW</td><td>GH</td><td>GM</td><td>KE</td><td>LR</td><td>LS</td><td>MW</td> </tr> <tr> <td>MZ</td><td>NA</td><td>RW</td><td>SC</td><td>SD</td><td>SL</td><td>ST</td> </tr> <tr> <td>SZ</td><td>TZ</td><td>UG</td><td>ZM</td><td>ZW</td><td></td><td></td> </tr> </table>	BW	GH	GM	KE	LR	LS	MW	MZ	NA	RW	SC	SD	SL	ST	SZ	TZ	UG	ZM	ZW				
BW	GH	GM	KE	LR	LS	MW																	
MZ	NA	RW	SC	SD	SL	ST																	
SZ	TZ	UG	ZM	ZW																			

**(51) International Classification :** G01N 33/24 (2006.01)

G06Q 10/06 (2012.01)

**(54) Title**  
 A METHOD OF MEASURING SOIL

**(57) Abstract**

A method of measuring soil, the method including the steps of assessing the characteristics of a landscape under inspection to identify one or more feature groups of the landscape under inspection and the amount of area of land of each of the feature groups; identifying sampling locations in each of the feature groups; undertaking soil sampling at each identified sampling locations to calculate the content of the feature of the soil in each of the feature groups; and calculating the content of the feature of the landscape under inspection using the calculated content of a feature of the soil of each of the feature groups and the amount of area of land of each feature group as a proportion of the total area of the landscape under inspection.

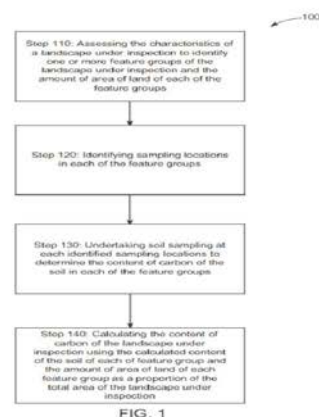

**(56) Documents Cited :** CN 105699624 B

US 2020/0178459 A1

CN 110596343 A

## Patents Granted (Contd.)

FORM 25	(12) PATENT	(19) AP																					
<p><b>(11) Patent No :</b> AP 7822</p> <p><b>(21) Application No :</b> AP/P/2022/014001</p> <p><b>(22) Filing Date :</b> 07.10.2020</p> <p><b>(24) Date of Grant &amp; (45) Publication :</b> 09/07/2025</p>	<p><b>(73) Applicant(s)</b> OAK CREST INSTITUTE OF SCIENCE, Oak Crest Institute Of Science, 132 West Chestnut Avenue, Monrovia, CA 91016, United States of America</p>	<p><b>(72) Inventors</b> ANTON Peter A, United States of America MOSS John A, United States of America BAUM Marc M, United States of America</p>																					
<p><b>(30) Priority Data</b></p> <table style="width: 100%; border-collapse: collapse;"> <thead> <tr> <th style="text-align: left;">(33) Country</th> <th style="text-align: left;">(31) Number</th> <th style="text-align: left;">(32) Date</th> </tr> </thead> <tbody> <tr> <td>US</td> <td>62/911,765</td> <td>07.10.2019</td> </tr> <tr> <td>US</td> <td>62/941,267</td> <td>27.11.2019</td> </tr> <tr> <td>US</td> <td>63/061,483</td> <td>05.08.2020</td> </tr> </tbody> </table>	(33) Country	(31) Number	(32) Date	US	62/911,765	07.10.2019	US	62/941,267	27.11.2019	US	63/061,483	05.08.2020	<p><b>(74) Representative</b> FISHER CORMACK &amp; BOTHA, Malawi</p>										
(33) Country	(31) Number	(32) Date																					
US	62/911,765	07.10.2019																					
US	62/941,267	27.11.2019																					
US	63/061,483	05.08.2020																					
<p><b>(84) Designated States:</b></p> <table style="width: 100%; border-collapse: collapse;"> <tr> <td>BW</td><td>GH</td><td>GM</td><td>KE</td><td>LR</td><td>LS</td><td>MW</td> </tr> <tr> <td>MZ</td><td>NA</td><td>RW</td><td>SD</td><td>SL</td><td>ST</td><td>SZ</td> </tr> <tr> <td>TZ</td><td>UG</td><td>ZM</td><td>ZW</td><td></td><td></td><td></td> </tr> </table>	BW	GH	GM	KE	LR	LS	MW	MZ	NA	RW	SD	SL	ST	SZ	TZ	UG	ZM	ZW					
BW	GH	GM	KE	LR	LS	MW																	
MZ	NA	RW	SD	SL	ST	SZ																	
TZ	UG	ZM	ZW																				

**(51) International Classification :** A61K 9/00 (2006.01)

**(54) Title**  
ORALLY IMPLANTABLE DRUG DELIVERY DEVICE

**(57) Abstract**

Disclosed herein are buccal implant devices comprising a body having a non-cylindrical geometry, the body adapted to be disposed within the oral cavity of a patient (e.g., the oral mucosa of a patient), and one or more pharmaceutically active ingredients. Also disclosed are methods of using the buccal implant devices in treating or preventing medical conditions.

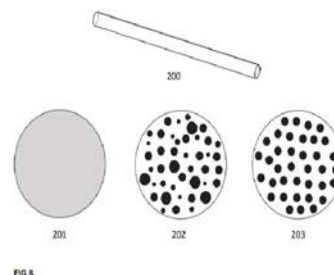

**(56) Documents Cited :** WO 2016149561 A1

US 4020558 A

## Patents Granted (Contd.)

FORM 25	(12) PATENT	(19) AP												
<p><b>(11) Patent No :</b> AP 7823</p> <p><b>(21) Application No :</b> AP/P/2022/013834</p> <p><b>(22) Filing Date :</b> 13.07.2020</p> <p><b>(24) Date of Grant &amp; (45) Publication :</b> 15/07/2025</p>	<p><b>(73) Applicant(s)</b> SICPA HOLDING SA, Avenue de Florissant 41, 1008 Prilly, Switzerland</p> <p><b>(72) Inventors</b> KOWALSKI Mark, United States of America SCHEFFLER Raymond H, United States of America PIOTTI Marcelo Eduardo, United States of America</p> <p><b>(74) Representative</b> ADAMS AND ADAMS MOZAMBIQUE, Mozambique</p>													
<p><b>(30) Priority Data</b></p> <table style="width: 100%; border-collapse: collapse;"> <thead> <tr> <th style="text-align: left;">(33) Country</th> <th style="text-align: left;">(31) Number</th> <th style="text-align: left;">(32) Date</th> </tr> </thead> <tbody> <tr> <td>US</td> <td>62/874,158</td> <td>15.07.2019</td> </tr> <tr> <td>EP</td> <td>19192040.4</td> <td>16.08.2019</td> </tr> <tr> <td>EP</td> <td>20163879.8</td> <td>18.03.2020</td> </tr> </tbody> </table>	(33) Country	(31) Number	(32) Date	US	62/874,158	15.07.2019	EP	19192040.4	16.08.2019	EP	20163879.8	18.03.2020		
(33) Country	(31) Number	(32) Date												
US	62/874,158	15.07.2019												
EP	19192040.4	16.08.2019												
EP	20163879.8	18.03.2020												
<p><b>(84) Designated States:</b> GH</p>														

**(51) International Classification :** G01N 21/00 (2006.01) B01J 13/00 (2006.01)  
 B82Y 10/00 (2011.01) B82Y 20/00 (2011.01)  
 B82Y 40/00 (2011.01) G01N 21/65 (2006.01)

**(54) Title**  
METHOD FOR MANUFACTURING SURFACE ENHANCED RAMAN SPECTROSCOPY TAGS

**(57) Abstract**

The present invention relates to the field of methods of manufacturing of surface enhanced Raman spectroscopy (SERS) tags. The manufacturing method according to the present invention is reproducible and versatile and enables the production in an expedient manner of high quantities of SERS tags characterized by a narrow size distribution and a high ratio of low-number aggregates. SERS tags manufactured by the inventive manufacturing method described herein provide increased ensemble SERS responses.

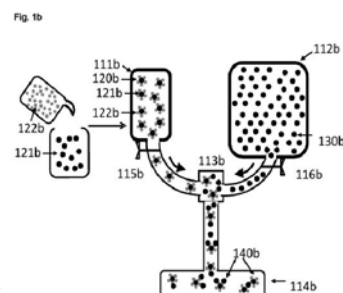

**(56) Documents Cited :** US 2008/0118986 A1  
US 2008/0003576 A1

US 2005/0142567 A1  
US 2008/0081340 A1

US 2006/0038979 A1  
WO 2011/119589 A1

### Patents Granted (Contd.)

FORM 25	(12) PATENT	(19) AP						
<b>(11) Patent No :</b> AP 7824 <b>(21) Application No :</b> AP/P/2023/014615 <b>(22) Filing Date :</b> 09.07.2021 <b>(24) Date of Grant &amp; (45) Publication :</b> 15/07/2025		<b>(73) Applicant(s)</b> TELEFONAKTIEBOLAGET LM ERICSSON (PUBL), 164 83 Stockholm, Sweden						
<b>(30) Priority Data</b> <table style="width: 100%; border-collapse: collapse;"> <tr> <td style="text-align: center;"><b>(33) Country</b></td> <td style="text-align: center;"><b>(31) Number</b></td> <td style="text-align: center;"><b>(32) Date</b></td> </tr> <tr> <td style="text-align: center;">US</td> <td style="text-align: center;">63/061,964</td> <td style="text-align: center;">06.08.2020</td> </tr> </table>	<b>(33) Country</b>	<b>(31) Number</b>	<b>(32) Date</b>	US	63/061,964	06.08.2020		<b>(72) Inventors</b> DA SILVA Icaro Leonardo, Sweden WAGER Stefan, Finland
<b>(33) Country</b>	<b>(31) Number</b>	<b>(32) Date</b>						
US	63/061,964	06.08.2020						
<b>(84) Designated States:</b> TZ		<b>(74) Representative</b> ROLAND INTELLECTUAL PROPERTY CONSULTANTS, Namibia						

**(51) International Classification :** H04W 76/19 (2018.01)      H04W 52/02 (2009.01)  
H04W 36/00 (2009.01)      H04W 76/15 (2018.01)

**(54) Title**  
CONFIGURING A WIRELESS DEVICE CONFIGURED WITH MULTI-RADIO ACCESS TECHNOLOGY DUAL CONNECTIVITY

**(57) Abstract**  
Methods and apparatus are disclosed, including in an example a method performed by a wireless device configured with Multi-Radio Access Technology Dual Connectivity (MR-DC). The method comprises receiving, from a first network node, at least one message in a reconfiguration procedure for a first cell group. The at least one message indicates a mode of operation of the wireless device for a second cell group by the wireless device.

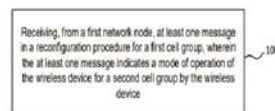

1000  
**FIG. 10**

## Patents Granted (Contd.)

FORM 25	(12) PATENT	(19) AP																					
<p>(11) Patent No : AP 7825</p> <p>(21) Application No : AP/P/2023/015005</p> <p>(22) Filing Date : 15.12.2021</p> <p>(24) Date of Grant &amp; (45) Publication : 15/07/2025</p>	<p><b>(73) Applicant(s)</b>                      NUCTECH COMPANY LIMITED, 2nd Floor, Block A, Tongfang Building, Shuangqinglu, Haidian District Beijing 100084, China                      TSINGHUA UNIVERSITY, Qing Hua Yuan, Haidian District Beijing 100084, China</p>																						
<p>(30) Priority Data</p> <table style="width: 100%; border-collapse: collapse;"> <thead> <tr> <th style="text-align: left;">(33) Country</th> <th style="text-align: left;">(31) Number</th> <th style="text-align: left;">(32) Date</th> </tr> </thead> <tbody> <tr> <td>CN</td> <td>202011639188.6</td> <td>31.12.2020</td> </tr> </tbody> </table>	(33) Country	(31) Number	(32) Date	CN	202011639188.6	31.12.2020	<p><b>(72) Inventors</b>                      HU Yu, Peoples Republic of China                      JI Zheng, Peoples Republic of China                      MA Yuan, Peoples Republic of China                      et al</p>																
(33) Country	(31) Number	(32) Date																					
CN	202011639188.6	31.12.2020																					
<p>(84) Designated States:</p> <table style="width: 100%; border-collapse: collapse;"> <tr> <td style="padding-right: 10px;">BW</td> <td style="padding-right: 10px;">GH</td> <td style="padding-right: 10px;">GM</td> <td style="padding-right: 10px;">KE</td> <td style="padding-right: 10px;">LR</td> <td style="padding-right: 10px;">LS</td> <td style="padding-right: 10px;">MW</td> </tr> <tr> <td>MZ</td> <td>NA</td> <td>RW</td> <td>SD</td> <td>SL</td> <td>ST</td> <td>SZ</td> </tr> <tr> <td>TZ</td> <td>UG</td> <td>ZM</td> <td>ZW</td> <td></td> <td></td> <td></td> </tr> </table>	BW	GH	GM	KE	LR	LS	MW	MZ	NA	RW	SD	SL	ST	SZ	TZ	UG	ZM	ZW				<p><b>(74) Representative</b>                      FISHER CORMACK &amp; BOTHA, Malawi</p>	
BW	GH	GM	KE	LR	LS	MW																	
MZ	NA	RW	SD	SL	ST	SZ																	
TZ	UG	ZM	ZW																				

(51) International Classification : G01V 5/00 (2006.01) G01N 23/10 (2018.01)

(54) Title  
RADIATION INSPECTION SYSTEM

**(57) Abstract**

The present disclosure provides a radiation inspection system, including a container (1) respectively provided with an entrance (A) and an exit (B) on opposite side walls thereof; and a radiation scanning imaging device (2) disposed in the container (1) and having an inspection channel (G). The radiation scanning imaging device (2) includes a ray source (21), the ray source (21) includes a plurality of ray generators (21'), and the plurality of ray generators (21') are configured to emit ray beams at different angles, so that the radiation scanning imaging device (2) performs radiation scanning inspection on an object to be inspected passing through the inspection channel (G) from the entrance (A) to the exit (B).

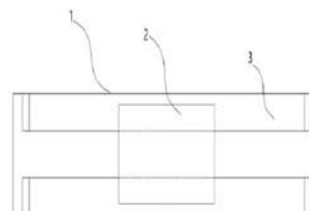

Fig 1

(56) Documents Cited : CN 110286414 A  
CN 106353831 A

CN 104991282 A  
JP 2021071360 A

CN 103226114 A

## Patents Granted (Contd.)

FORM 25	(12) PATENT	(19) AP						
<p><b>(11) Patent No :</b> AP 7826</p> <p><b>(21) Application No :</b> AP/P/2022/013933</p> <p><b>(22) Filing Date :</b> 29.03.2022</p> <p><b>(24) Date of Grant &amp; (45) Publication :</b> 16/07/2025</p>	<p><b>(73) Applicant(s)</b> MUSASHI SEIMITSU INDUSTRY CO., LTD., 39-5, Aza Daizen, Ueta-cho, Toyohashi-shi, Aichi 4418560, Japan</p>							
<p><b>(30) Priority Data</b></p> <table style="width: 100%; border-collapse: collapse;"> <thead> <tr> <th style="text-align: left;">(33) Country</th> <th style="text-align: left;">(31) Number</th> <th style="text-align: left;">(32) Date</th> </tr> </thead> <tbody> <tr> <td>IN</td> <td>202111014346</td> <td>30.03.2021</td> </tr> </tbody> </table>	(33) Country	(31) Number	(32) Date	IN	202111014346	30.03.2021	<p><b>(72) Inventors</b> YAMAMOTO Kenta, Japan MUKAI Masamichi, Japan OKAMOTO Teruhisa, Japan</p>	
(33) Country	(31) Number	(32) Date						
IN	202111014346	30.03.2021						
<p><b>(84) Designated States:</b> KE RW UG</p>	<p><b>(74) Representative</b> ADAMS AND ADAMS MOZAMBIQUE, Mozambique</p>							

**(51) International Classification :** B62M7/B62K11(2016.01)  
B62K22B62K22(2016.01)

B62J43/B62K25(2016.01)

**(54) Title**  
BREATHER STRUCTURE OF ELECTRIC VEHICLE

**(57) Abstract**

By attaching a power unit (P) to a swing arm (51) at a 1st attachment portion (31a), a gas-liquid separation chamber (100) having an atmosphere opening hole (105) is formed between the 1st attachment portion (31a) and the swing arm (51). Since the gas-liquid separation chamber (100) is communicated with a breather chamber (80) through a hose (120), and the breather chamber (80) is communicated with a gear chamber (43), the pressure of the gear chamber (43) can be released to the atmosphere after being guided to the gas-liquid separation chamber (100). Thus, even if rainwater or the like enters the gas-liquid separation chamber (100) from the atmosphere opening hole (105), the gas-liquid separation chamber (100) functions as a water storage tank, so that the rainwater or the like can be suppressed from flowing back to the gear chamber (43), and waterproofness of the breather structure can be enhanced.

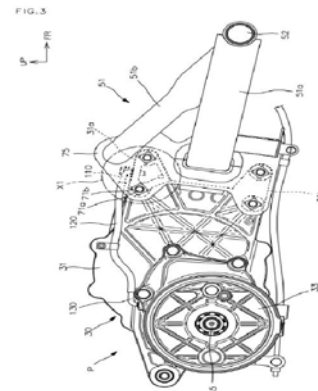

**(56) Documents Cited :** US 9 457 869 B2  
US 2003/0015366 A1

US 2008/0093133 A1  
JP-H05-105177 A

WO 2020/067269 A1  
US 2017/0288490 A1

## Patents Granted (Contd.)

FORM 25	(12) PATENT	(19) AP															
<p>(11) Patent No : AP 7827</p> <p>(21) Application No : AP/P/2022/014534</p> <p>(22) Filing Date : 11.05.2020</p> <p>(24) Date of Grant &amp; (45) Publication : 16/07/2025</p>	<p>(73) Applicant(s) ROYAL EIJKELKAMP B.V., Nijverheidsstraat 9 6987 EN Giesbeek, The Netherlands</p>	<p>(72) Inventors EIJKELKAMP Hugo Jaap, The Netherlands</p>															
<p>(30) Priority Data</p> <table style="width: 100%; border-collapse: collapse;"> <thead> <tr> <th style="text-align: left;">(33) Country</th> <th style="text-align: left;">(31) Number</th> <th style="text-align: left;">(32) Date</th> </tr> </thead> <tbody> <tr> <td>BW</td> <td>GH</td> <td>GM</td> </tr> <tr> <td>MZ</td> <td>NA</td> <td>RW</td> </tr> <tr> <td>TZ</td> <td>UG</td> <td>ZM</td> </tr> <tr> <td></td> <td></td> <td>ZW</td> </tr> </tbody> </table>	(33) Country	(31) Number	(32) Date	BW	GH	GM	MZ	NA	RW	TZ	UG	ZM			ZW	<p>(74) Representative FISHER CORMACK &amp; BOTHA, Malawi</p>	
(33) Country	(31) Number	(32) Date															
BW	GH	GM															
MZ	NA	RW															
TZ	UG	ZM															
		ZW															
<p>(51) International Classification : E02D 3/12 (2006.01) E02D 19/16 (2006.01)</p>	<p>E02D 19/12 (2006.01) C09K 17/12 (2006.01)</p>																
<p>(54) Title METHOD FOR PROVIDING AN UNDERGROUND BARRIER</p>																	
<p>(57) Abstract</p> <p>The invention relates to a method for providing an underground barrier for a water flow, which method comprises the steps of: - drilling in soil a number of parallel vertical holes; - inserting pipe strings into the drilled holes, wherein each pipe string has a pipe string wall with a plurality of openings arranged distributed along the length of the pipe string; - introducing injector means in each of the pipe strings; - positioning the injector means at a plurality of discrete depths in the respective pipe string and aligned at each depth with at least one of the openings in the pipe string wall; - injecting at each discrete depth a sealing compound, such as sodium silicate, through the at least one aligned opening into the soil.</p>																	



Fig. 1A

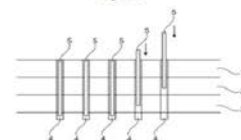

Fig. 1B

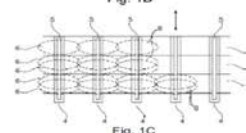

Fig. 1C

(56) Documents Cited : US 3 300 984 A  
JP S58 156618 A

US 2009/0304457 A1  
WO 2008/033536 A2

US 4 697 953 A  
US 5 027 908 A

## Patents Granted (Contd.)

FORM 25	(12) PATENT	(19) AP									
<p><b>(11) Patent No :</b> AP 7828</p> <p><b>(21) Application No :</b> AP/P/2021/013469</p> <p><b>(22) Filing Date :</b> 23.05.2019</p> <p><b>(24) Date of Grant &amp; (45) Publication :</b> 17/07/2025</p>	<p><b>(73) Applicant(s)</b> ACO AHLMANN SE &amp; CO. KG., AM Ahlmannkai, 24782 Büdelsdorf, Germany</p>										
<p><b>(30) Priority Data</b></p> <table style="width: 100%; border-collapse: collapse;"> <thead> <tr> <th style="text-align: left;">(33) Country</th> <th style="text-align: left;">(31) Number</th> <th style="text-align: left;">(32) Date</th> </tr> </thead> <tbody> <tr> <td>EP</td> <td>PCT/EP2019/05433</td> <td>21.02.2019</td> </tr> <tr> <td>EP</td> <td>PCT/EP2019/05433</td> <td>21.02.2019</td> </tr> </tbody> </table>	(33) Country	(31) Number	(32) Date	EP	PCT/EP2019/05433	21.02.2019	EP	PCT/EP2019/05433	21.02.2019	<p><b>(72) Inventors</b> MEINCKE Arne, Germany MÜLLER-BAKU Sascha, Germany WANDKOWSKI Marco, Germany</p>	
(33) Country	(31) Number	(32) Date									
EP	PCT/EP2019/05433	21.02.2019									
EP	PCT/EP2019/05433	21.02.2019									
<p><b>(84) Designated States:</b> GH KE</p>	<p><b>(74) Representative</b> GALLOWAY &amp; COMPANY, Zimbabwe</p>										

**(51) International Classification :** E01C 11/22 (2006.01) E03F 3/04 (2006.01)  
F16L 37/098 (2006.01) E03F 5/06 (2006.01)

**(54) Title**  
DRAINAGE SYSTEM, DRAINAGE UNITS, AND METHOD

**(57) Abstract**

A drainage system (1) comprising: at least one water receiving unit (20) having: a water receptacle (22) for receiving water from an adjoining surface; a first neck piece (24) which can be connected to the water receptacle (22) and provided such that water can flow out of the water receiving unit (20) through an opening (26) of the first neck piece (24); and at least one water drainage unit (40) for draining the water, comprising: a pipe body (42); and a first opening (46b), provided on the pipe body (42), for receiving the water in said pipe body (42); wherein: the water drainage unit (40) can be provided and oriented under the surface such that the opening (26) of the first neck piece (24) and the first opening (46b) of the pipe body (42) can be connected and the water flowing out of the water receiving unit (20) can flow into the water drainage unit (40). Also disclosed are drainage units and methods.

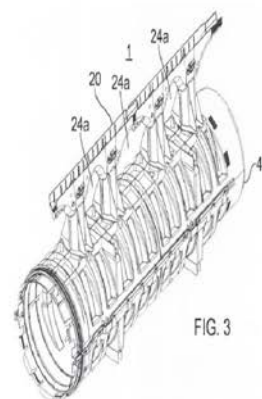

FIG. 3

**(56) Documents Cited :** EP 2 522 773 A2  
EP 1 380 691 A2

DE 20 2005 004634 U1  
CN 108 331 130 A

EP 2 520 728 A1  
GB 2 311 549 A

## Patents Granted (Contd.)

FORM 25	(12) PATENT	(19) AP						
<p><b>(11) Patent No :</b> AP 7829</p> <p><b>(21) Application No :</b> AP/P/2021/013632</p> <p><b>(22) Filing Date :</b> 30.06.2020</p> <p><b>(24) Date of Grant &amp; (45) Publication :</b> 17/07/2025</p>	<p><b>(73) Applicant(s)</b> BAJAJ AUTO LIMITED, At Akurdi, Mumbai-Pune Road, Pune, Maharashtra, 411035, India</p>							
<p><b>(30) Priority Data</b></p> <table style="width: 100%; border-collapse: collapse;"> <thead> <tr> <th style="text-align: left;">(33) Country</th> <th style="text-align: left;">(31) Number</th> <th style="text-align: left;">(32) Date</th> </tr> </thead> <tbody> <tr> <td>IN</td> <td>201921026198</td> <td>01.07.2019</td> </tr> </tbody> </table>	(33) Country	(31) Number	(32) Date	IN	201921026198	01.07.2019	<p><b>(72) Inventors</b> JOSH Hrishikesh Waman, India KRISHNA E Vamsi, India</p>	
(33) Country	(31) Number	(32) Date						
IN	201921026198	01.07.2019						
<p><b>(84) Designated States:</b> GH KE TZ UG</p>	<p><b>(74) Representative</b> FISHER CORMACK &amp; BOTHA, Malawi</p>							

**(51) International Classification :** H03K 17/00 (2006.01) B60R 25/021 (2013.01) H03K 17/94 (2006.01)

**(54) Title**  
AN ANTI-THEFT SYSTEM FOR VEHICLE

**(57) Abstract**

The present invention provides an anti-theft system for vehicle comprising; an ignition switch (200); an electronic circuit (250) configured to generate at least one signal upon receiving power from a battery (220) through ignition switch (200); a control unit (270) configured to receive the signal generated by said electronic circuit (250) and said control unit (270) is in connection with at least one vehicle component; wherein, the ignition switch (200) comprises a mechanism configured to connect at least a single input with multiple outputs to enable power supply from power source (220) to the electronic circuit (250) and to the control unit (270) from battery wherein; the control unit (270) is configured to allow starting of vehicle by enabling functioning of at least one of the vehicle component after authenticating the signal received from the electronic circuit (250).

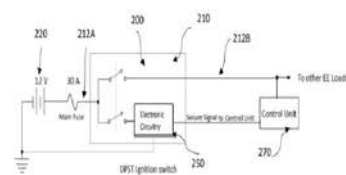

FIG. 3

**(56) Documents Cited :** US 4 993 627 A  
GB 2 266 747 A

US Department of Commerce,  
US 49 Code of Federal Regulat

CA 2 125 814 A1  
CA 1 113 588 A

### Patents Granted (Contd.)

FORM 25	(12) PATENT	(19) AP																					
<p><b>(11) Patent No :</b> AP 7830</p> <p><b>(21) Application No :</b> AP/P/2023/015411</p> <p><b>(22) Filing Date :</b> 23.06.2022</p> <p><b>(24) Date of Grant &amp; (45) Publication :</b> 22/07/2025</p>	<p><b>(73) Applicant(s)</b> HISHAB INDIA PRIVATE LIMITED, E-13/29, First Floor, Harsha Bhawan, Connaught Place, New Delhi 110001, India</p>	<p><b>(72) Inventors</b> VOIGT Christopher, Germany KHAN Alam Aseequl, Bangladesh HOSSAIN Mohammad Fayadan, Bangladesh et al</p>																					
<p><b>(30) Priority Data</b></p> <table style="width: 100%; border-collapse: collapse;"> <tr> <th style="text-align: left;">(33) Country</th> <th style="text-align: left;">(31) Number</th> <th style="text-align: left;">(32) Date</th> </tr> <tr> <td>BD</td> <td>P/BD/2021/000192</td> <td>23.06.2021</td> </tr> </table>	(33) Country	(31) Number	(32) Date	BD	P/BD/2021/000192	23.06.2021	<p><b>(74) Representative</b> ROLAND INTELLECTUAL PROPERTY CONSULTANTS, Namibia</p>																
(33) Country	(31) Number	(32) Date																					
BD	P/BD/2021/000192	23.06.2021																					
<p><b>(84) Designated States:</b></p> <table style="width: 100%; border-collapse: collapse;"> <tr> <td>BW</td><td>GH</td><td>GM</td><td>KE</td><td>LR</td><td>LS</td><td>MW</td> </tr> <tr> <td>MZ</td><td>NA</td><td>RW</td><td>SC</td><td>SD</td><td>SL</td><td>ST</td> </tr> <tr> <td>SZ</td><td>TZ</td><td>UG</td><td>ZM</td><td>ZW</td><td></td><td></td> </tr> </table>	BW	GH	GM	KE	LR	LS	MW	MZ	NA	RW	SC	SD	SL	ST	SZ	TZ	UG	ZM	ZW				
BW	GH	GM	KE	LR	LS	MW																	
MZ	NA	RW	SC	SD	SL	ST																	
SZ	TZ	UG	ZM	ZW																			

**(51) International Classification :** G06F 3/01 (2006.01)

G06F 3/16 (2006.01)

**(54) Title**  
A SYSTEM AND METHOD FOR DELIVERING DOMAIN OR USE-CASE SWITCH SUGGESTION FOR AN ONGOING CONVERSATION

**(57) Abstract**

A system and method are described for dialogue management by determining a transition from a domain or a use case to another and initiating a switch suggestion in a human-computer conversation for rendering services to a user based on the updated domain or use case for a dialogue. The method comprises determining a first use-case in the human-computer conversation and assigning a first use-case score to the said first use-case. The method then comprises determining a second use-case in the human-computer conversation and assigning a second use-case score to the said second use-case. Further, the method comprises determining whether to make the use-case switch suggestion to the said second use-case based on the said first use-case score and the said second use-case score. The invention aligns the system to extract intended information from/for the user thereby making the system more efficient, approachable and user-friendly by saving time and cost.

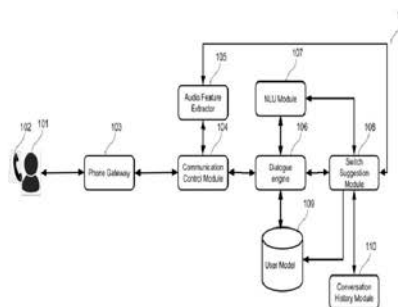

Figure 1A

**(56) Documents Cited :** JP 2019-070957 A

JP 2020-087352 A

JP 2019-028783 A

## Patents Granted (Contd.)

FORM 25	(12) PATENT	(19) AP																								
<p>(11) Patent No : AP 7831</p> <p>(21) Application No : AP/P/2022/014230</p> <p>(22) Filing Date : 17.04.2020</p> <p>(24) Date of Grant &amp; (45) Publication : 25/07/2025</p>	<p>(73) Applicant(s) METSO FINLAND OY, Rauhalanpuisto 9 02230 Espoo, Finland</p> <p>(72) Inventors JUVONEN Ismo, Finland ELORANTA Teemu, Finland MUSTAKANGAS Mirva, Finland et al</p> <p>(74) Representative FISHER CORMACK &amp; BOTHA, Malawi</p>	<p>(30) Priority Data</p> <table style="width: 100%; border-collapse: collapse;"> <thead> <tr> <th style="text-align: left;">(33) Country</th> <th style="text-align: left;">(31) Number</th> <th style="text-align: left;">(32) Date</th> </tr> </thead> <tbody> <tr> <td>BW</td> <td>GH</td> <td>GM</td> <td>KE</td> <td>LR</td> <td>LS</td> <td>MW</td> </tr> <tr> <td>MZ</td> <td>NA</td> <td>RW</td> <td>SD</td> <td>SL</td> <td>ST</td> <td>SZ</td> </tr> <tr> <td>TZ</td> <td>UG</td> <td>ZM</td> <td>ZW</td> <td></td> <td></td> <td></td> </tr> </tbody> </table>	(33) Country	(31) Number	(32) Date	BW	GH	GM	KE	LR	LS	MW	MZ	NA	RW	SD	SL	ST	SZ	TZ	UG	ZM	ZW			
(33) Country	(31) Number	(32) Date																								
BW	GH	GM	KE	LR	LS	MW																				
MZ	NA	RW	SD	SL	ST	SZ																				
TZ	UG	ZM	ZW																							
<p>(51) International Classification : B01D 25/127 (2006.01) B01D 25/168 (2006.01) F16J 15/02 (2006.01)</p>	<p>B01D 25/28 (2006.01) B01D 25/164 (2006.01) F16J 15/12 (2006.01)</p>	<p>(54) Title SEALING STRIP, FILTER FRAME, FILTER FRAME ASSEMBLY AND FILTER APPARATUS</p> <p>(57) Abstract The disclosure relates to a sealing strip (1) for sealing adjacent filter plate assemblies of a horizontal filter press. The disclosure is based on the idea of providing the sealing strip (1) with a stiffener (6) at a base portion (3) of the sealing strip (1), positioned such that it intersects with a line running through a ridge (4a) provided on a distal portion (4) of the sealing strip (1) and extending along a vertical direction, perpendicular to both the length direction and the width direction of the sealing strip, as seen along the cross-sectional profile of the sealing strip (1). The disclosure further relates to a filter frame, a filter frame assembly and a filter apparatus having such a sealing strip.</p>																								
		<p style="text-align: center;">Fig. 1</p>																								
<p>(56) Documents Cited : WO 2017068241 A1 WO 2018150075 A1</p>	<p>US 4597583 A US 2014138919 A1</p>	<p>CN 209348196 U US 2012049409 A1</p>																								

## Patents Granted (Contd.)

FORM 25	(12) PATENT	(19) AP						
<p><b>(11) Patent No :</b> AP 7832</p> <p><b>(21) Application No :</b> AP/P/2021/013732</p> <p><b>(22) Filing Date :</b> 28.05.2020</p> <p><b>(24) Date of Grant &amp; (45) Publication :</b> 29/07/2025</p>	<p><b>(73) Applicant(s)</b> SICPA HOLDING SA, Avenue de Florissant 41, 1008 Prilly, Switzerland</p> <p><b>(72) Inventors</b> DECOUX Eric, Switzerland</p> <p><b>(74) Representative</b> ADAMS AND ADAMS MOZAMBIQUE, Mozambique</p>							
<p><b>(30) Priority Data</b></p> <table style="width: 100%; border-collapse: collapse;"> <thead> <tr> <th style="text-align: left;">(33) Country</th> <th style="text-align: left;">(31) Number</th> <th style="text-align: left;">(32) Date</th> </tr> </thead> <tbody> <tr> <td>EP</td> <td>19177919.8</td> <td>03.06.2019</td> </tr> </tbody> </table>	(33) Country	(31) Number	(32) Date	EP	19177919.8	03.06.2019		
(33) Country	(31) Number	(32) Date						
EP	19177919.8	03.06.2019						
<p><b>(84) Designated States:</b> KE TZ UG</p>								

**(51) International Classification :** G07D 7/00 (2016.01)      G07D 7/12 (2016.01)  
 G07D 7/20 (2016.01)      G07D 7/0043 (2016.01)  
 G07D 7/0047 (2016.01)

**(54) Title**  
CERTIFIED TEXT DOCUMENT

**(57) Abstract**

The invention protects a content of a digital or physical document against forgery. It allows automatic detection of any modification in an arrangement of graphical symbols (e.g. a text) provided on a support (e.g. printed or displayed) with respect to an original arrangement by providing on the support reproducible verifiable data including a verification barcode, while eliminating redundancy between data inside the barcode and the graphical symbols, and resolving the problem of the size of the barcode when the size of the data for these graphical symbols is large.



Fig.1

**(56) Documents Cited :** US 6047093 A  
US 2002/164052 A1

EP 2048867 A1  
US 2015/0052615 A1

US 2004/145661 A1

## Patents Granted (Contd.)

FORM 25	(12) PATENT	(19) AP						
<p>(11) Patent No : AP 7833</p> <p>(21) Application No : AP/P/2022/014565</p> <p>(22) Filing Date : 29.06.2021</p> <p>(24) Date of Grant &amp; (45) Publication : 29/07/2025</p>	<p>(73) Applicant(s) SANDVIK MINING AND CONSTRUCTION TOOLS AB, 81181 Sandviken, Sweden</p>	<p>(72) Inventors HAMMARGREN John, Sweden</p>						
<p>(30) Priority Data</p> <table style="width: 100%; border-collapse: collapse;"> <thead> <tr> <th style="text-align: left;">(33) Country</th> <th style="text-align: left;">(31) Number</th> <th style="text-align: left;">(32) Date</th> </tr> </thead> <tbody> <tr> <td>EP</td> <td>20183128.6</td> <td>30.06.2020</td> </tr> </tbody> </table>	(33) Country	(31) Number	(32) Date	EP	20183128.6	30.06.2020	<p>(74) Representative ADAMS AND ADAMS MOZAMBIQUE, Mozambique</p>	
(33) Country	(31) Number	(32) Date						
EP	20183128.6	30.06.2020						
<p>(84) Designated States: KE TZ ZM</p>								

(51) International Classification : E21B 17/02 (2006.01)

E21B 17/042 (2006.01)

(54) Title  
THREAD CLEARANCE

(57) Abstract

A female portion to form part of a thread joint for a percussive drilling tool comprising a mounting sleeve having an axial end, wherein the mounting sleeve surrounds an internal cavity having an axial inner wall at the opposing end of the mounting sleeve compared to the axial end; wherein the mounting sleeve has at least one substantially cylindrical internally threaded section having a length  $L_1$ , a thread entrance towards the axial end and a thread exit towards the axial inner wall; a thread clearance section positioned between the axial inner wall and the thread exit having a length  $L_2$  and a diameter  $D_1$ ; a guiding section positioned between the thread entrance and the axial end of the sleeve having a length,  $L_3$ ; characterized in that:  $0 \text{ mm} < L_3 - L_2 < 12 \text{ mm}$ .

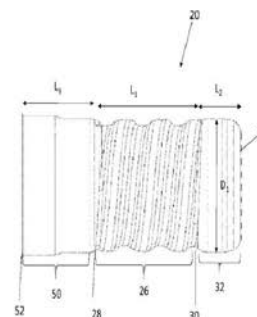

Fig. 5

(56) Documents Cited : US 4968068 A  
US 3537738 A

SE 520077 C2  
EP 2383420 A1

WO 03/042493 A1  
WO 01/38686 A1



## Patents Granted (Contd.)

FORM 25	(12) PATENT	(19) AP												
<p><b>(11) Patent No :</b> AP 7835</p> <p><b>(21) Application No :</b> AP/P/2021/013185</p> <p><b>(22) Filing Date :</b> 18.10.2019</p> <p><b>(24) Date of Grant &amp; (45) Publication :</b> 31/07/2025</p>	<p><b>(73) Applicant(s)</b> KORTUC JAPAN LLC, Shiroyama Trust Tower, 4F, 4-3-1 Toranomom, Minato-ku, Tokyo 1056004, Japan</p>	<p><b>(72) Inventors</b> YAMASHITA Shogo, Japan</p>												
<p><b>(30) Priority Data</b></p> <table border="1" style="width: 100%; border-collapse: collapse;"> <thead> <tr> <th style="width: 15%;">(33) Country</th> <th style="width: 25%;">(31) Number</th> <th style="width: 20%;">(32) Date</th> </tr> </thead> <tbody> <tr> <td>JP</td> <td>2018-215913</td> <td>16.11.2018</td> </tr> <tr> <td>JP</td> <td>2019-022388</td> <td>12.02.2019</td> </tr> <tr> <td>JP</td> <td>2019-115440</td> <td>21.06.2019</td> </tr> </tbody> </table>	(33) Country	(31) Number	(32) Date	JP	2018-215913	16.11.2018	JP	2019-022388	12.02.2019	JP	2019-115440	21.06.2019	<p><b>(74) Representative</b> FISHER CORMACK &amp; BOTHA, Malawi</p>	
(33) Country	(31) Number	(32) Date												
JP	2018-215913	16.11.2018												
JP	2019-022388	12.02.2019												
JP	2019-115440	21.06.2019												
<p><b>(84) Designated States:</b> KE RW</p>														

**(51) International Classification :** A61M 5/28 (2006.01) A61J 1/06 (2006.01)  
A61M 5/32 (2006.01)

**(54) Title**  
SYRINGE SUITABLE FOR HYDROGEN PEROXIDE SOLUTION AND KIT THEREOF

**(57) Abstract**  
A syringe that suppresses decomposition of hydrogen peroxide is provided. An object of the present invention is to provide a syringe includes a portion contacting a hydrogen peroxide solution, in which the portion is made of cycloolefin polymer (COP) or cycloolefin copolymer (COC).

[Fig. 11]

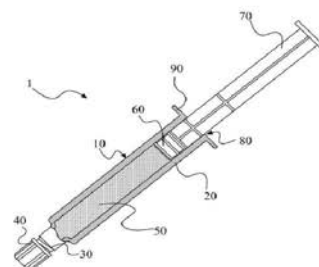

**(56) Documents Cited :** JP H07-250898 A  
WO 2014/187779 A1

US 2017/0065772 A1  
JP 2014-057632 A

WO 2018/070136 A1  
JP H08-206118 A

## Patents Granted (Contd.)

FORM 25	(12) PATENT	(19) AP																					
<p><b>(11) Patent No :</b> AP 7836</p> <p><b>(21) Application No :</b> AP/P/2021/013233</p> <p><b>(22) Filing Date :</b> 30.10.2019</p> <p><b>(24) Date of Grant &amp; (45) Publication :</b> 31/07/2025</p>	<p><b>(73) Applicant(s)</b> LABORATORIOS FARMACÉUTICOS ROVI, S.A., C/ Julián Camarillo, 35 28037 Madrid, Spain</p>	<p><b>(72) Inventors</b> GUTIERRO ADURIZ Ibón, Spain GARCÍA AMO María, Spain CEBADERA MIRANDA Elena, Spain</p>																					
<p><b>(30) Priority Data</b></p> <table style="width: 100%; border-collapse: collapse;"> <thead> <tr> <th style="text-align: left;">(33) Country</th> <th style="text-align: left;">(31) Number</th> <th style="text-align: left;">(32) Date</th> </tr> </thead> <tbody> <tr> <td>ES</td> <td>P201831060</td> <td>02.11.2018</td> </tr> </tbody> </table>	(33) Country	(31) Number	(32) Date	ES	P201831060	02.11.2018	<p><b>(74) Representative</b> Cronjé &amp; Co., Namibia</p>																
(33) Country	(31) Number	(32) Date																					
ES	P201831060	02.11.2018																					
<p><b>(84) Designated States:</b></p> <table style="width: 100%; border-collapse: collapse;"> <tbody> <tr> <td>BW</td><td>GH</td><td>GM</td><td>KE</td><td>LR</td><td>LS</td><td>MW</td> </tr> <tr> <td>MZ</td><td>NA</td><td>RW</td><td>SD</td><td>SL</td><td>ST</td><td>SZ</td> </tr> <tr> <td>TZ</td><td>UG</td><td>ZM</td><td>ZW</td><td></td><td></td><td></td> </tr> </tbody> </table>	BW	GH	GM	KE	LR	LS	MW	MZ	NA	RW	SD	SL	ST	SZ	TZ	UG	ZM	ZW					
BW	GH	GM	KE	LR	LS	MW																	
MZ	NA	RW	SD	SL	ST	SZ																	
TZ	UG	ZM	ZW																				

**(51) International Classification :** B65B 1/08 (2006.01) B65B 1/32 (2006.01)  
B65B 31/02 (2006.01)

**(54) Title**  
PROCEDURE FOR THE FILLING OF SOLIDS IN PHARMACEUTICAL CONTAINERS AND THE SEALING THEREOF UNDER STERILE CONDITIONS

**(57) Abstract**

A sterile procedure for the filling of solids in pharmaceutical containers and the sealing thereof under sterile conditions; among these being syringes, vials, capsules, ampoules, single-dose devices or cartridges filled with solid substances selected from the group formed by powder granules, pellets, nanoparticles or microparticles, obtaining the airtightness of said containers. More specifically, the procedure achieves the avoidance of the adherence of the aforementioned substances to the sides of the pharmaceutical containers, thus ensuring the airtightness of the seal of the container and likewise the exactitude of the weight of solid dispensed into the container.

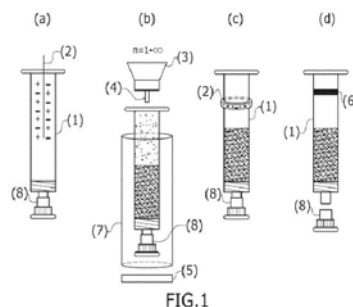

**(56) Documents Cited :** WO 2018/017561 A1  
US 2 524 560 A

WO 2016/185230 A2  
US 2017/0028130 A1

EP 2 078 674 A1  
US 6 065 270 A

## Patents Granted (Contd.)

FORM 25	(12) PATENT	(19) AP						
<p><b>(11) Patent No :</b> AP 7837</p> <p><b>(21) Application No :</b> AP/P/2021/013713</p> <p><b>(22) Filing Date :</b> 24.06.2020</p> <p><b>(24) Date of Grant &amp; (45) Publication :</b> 31/07/2025</p>	<p><b>(73) Applicant(s)</b> UNIVERSITY OF JOHANNESBURG, Cnr Kingsway Avenue and University Road, Auckland Park, Johannesburg 2006, South Africa</p>							
<p><b>(30) Priority Data</b></p> <table style="width: 100%; border-collapse: collapse;"> <tr> <td style="text-align: left;"><b>(33) Country</b></td> <td style="text-align: left;"><b>(31) Number</b></td> <td style="text-align: left;"><b>(32) Date</b></td> </tr> <tr> <td>ZA</td> <td>2019/04070</td> <td>24.06.2019</td> </tr> </table>	<b>(33) Country</b>	<b>(31) Number</b>	<b>(32) Date</b>	ZA	2019/04070	24.06.2019	<p><b>(72) Inventors</b> COOK Martin Nkululeko Hogan, South Africa CONNELL Simon Henry, South Africa</p>	
<b>(33) Country</b>	<b>(31) Number</b>	<b>(32) Date</b>						
ZA	2019/04070	24.06.2019						
<p><b>(84) Designated States:</b> BW LS NA</p>	<p><b>(74) Representative</b> ADAMS AND ADAMS MOZAMBIQUE, Mozambique</p>							

**(51) International Classification :** G06T 11/00 (2006.01)

**(54) Title**  
METHODS AND SYSTEMS FOR REDUCING ARTEFACTS IN IMAGE RECONSTRUCTION

**(57) Abstract**

The invention relates to methods and systems for reducing artefacts in image reconstruction employed in tomographic imaging including Positron Emission Tomography (PET) and Computer Assisted Tomography (CAT) or (CT). The method is carried out entirely or in part by a computer or computerised system communicatively coupled to a detector arrangement which comprises a plurality of detector elements, wherein the detector elements are configured to detect photons associated with an object during PET and CAT screening processes in at least medical and mining applications.

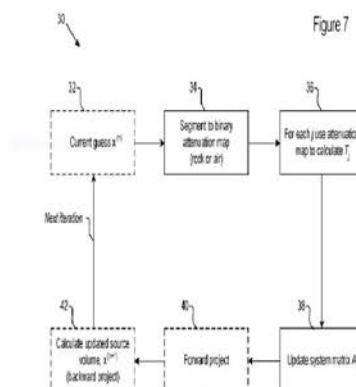

**(56) Documents Cited :** JOHAN NUYTS et al.

T Nemakhavhani et al.

US 2011/0007958 A1

### Patents Granted (Contd.)

FORM 25	(12) PATENT	(19) AP						
<p>(11) Patent No : AP 7838</p> <p>(21) Application No : AP/P/2022/014379</p> <p>(22) Filing Date : 31.10.2020</p> <p>(24) Date of Grant &amp; (45) Publication : 31/07/2025</p>	<p>(73) Applicant(s) THISCAP, INC., 286 Lake Drive San Bruno, California 94066, United States of America</p> <p>(72) Inventors MAGUIRE Michael Joseph, United States of America</p> <p>(74) Representative FISHER CORMACK &amp; BOTHA, Malawi</p>							
<p>(30) Priority Data</p> <table style="width: 100%; border-collapse: collapse;"> <thead> <tr> <th style="text-align: left;">(33) Country</th> <th style="text-align: left;">(31) Number</th> <th style="text-align: left;">(32) Date</th> </tr> </thead> <tbody> <tr> <td>US</td> <td>16/834,916</td> <td>30.03.2020</td> </tr> </tbody> </table>	(33) Country	(31) Number	(32) Date	US	16/834,916	30.03.2020		
(33) Country	(31) Number	(32) Date						
US	16/834,916	30.03.2020						
<p>(84) Designated States: GH KE MZ TZ UG ZM ZW</p>								

(51) International Classification : B65D 41/34 (2006.01)

(54) Title  
CAP FOR CONTAINER

(57) Abstract

A cap for a container is formed so that the cap has a top plate and a circular sidewall. Two opposite sides of the circular sidewall circularly connect to each other, one periphery of the circular sidewall connecting to one surface of the top plate forming a closed end, and another periphery of the circular sidewall at an opposite side of the closed end forms an opened end. Incisions are in the circular sidewall. The incisions form a ring member located at the opened end of the cap separated from a main body of the cap by a first incision and a second incision between the opened end of the main body and the ring member.

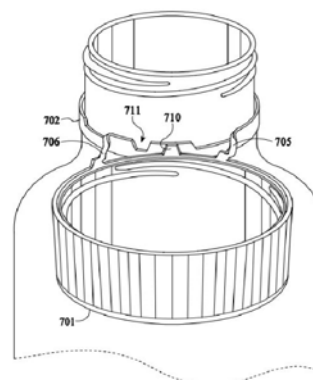

FIG. 34

(56) Documents Cited : US 2019344944 A1  
US 20150251827 A1

US20180370701 A1  
US 20110174760 A1

US 20190344933 A1  
US 20180170625 A1

## Patents Granted (Contd.)

FORM 25	(12) PATENT	(19) AP						
<p><b>(11) Patent No :</b> AP 7839</p> <p><b>(21) Application No :</b> AP/P/2022/014563</p> <p><b>(22) Filing Date :</b> 14.05.2021</p> <p><b>(24) Date of Grant &amp; (45) Publication :</b> 31/07/2025</p>	<p><b>(73) Applicant(s)</b> UNIVERSITÄT HOHENHEIM, Schloss Hohenheim 1 70599 Stuttgart, Germany</p>							
<p><b>(30) Priority Data</b></p> <table style="width: 100%; border-collapse: collapse;"> <thead> <tr> <th style="text-align: left;">(33) Country</th> <th style="text-align: left;">(31) Number</th> <th style="text-align: left;">(32) Date</th> </tr> </thead> <tbody> <tr> <td>EP</td> <td>20174927.2</td> <td>15.05.2020</td> </tr> </tbody> </table>	(33) Country	(31) Number	(32) Date	EP	20174927.2	15.05.2020	<p><b>(72) Inventors</b> BRANCH Oliver, Germany WULFMEYER Volker, Germany</p>	
(33) Country	(31) Number	(32) Date						
EP	20174927.2	15.05.2020						
<p><b>(84) Designated States:</b> BW GH KE MZ NA SD TZ</p>	<p><b>(74) Representative</b> ADAMS AND ADAMS MOZAMBIQUE, Mozambique</p>							

**(51) International Classification :**

B01D	5/00	(2006.01)	A01G	15/00	(2006.01)
F24S	20/40	(2018.01)	F24S	20/60	(2018.01)
F24S	21/00	(2018.01)	F24S	25/12	(2018.01)
F24S	40/44	(2018.01)	F24S	70/275	(2018.01)
F24S	20/00	(2018.01)	F24S	80/00	(2018.01)
E03B	3/02	(2006.01)	E03B	3/28	(2006.01)
H02S	20/10	(2014.01)			

**(54) Title**  
APPARATUS AND METHOD FOR OBTAINING FRESH WATER

**(57) Abstract**

Apparatus (10) for obtaining fresh water by artificially generating a precipitation. The apparatus (10) comprises at least one darkening body (14) that forms a darkening surface (12) which has a width and/or length of at least 3 km and an albedo of less than 0.1. The apparatus further comprises at least one base frame (22) which is configured to support the at least one darkening body (14) and to keep at least one darkening body (14) spaced apart from a support surface (16) in order to form a space (24) between the support surface (16) and the at least one darkening body (14). Still further, the apparatus (10) comprises a precipitation collection system (26) which is arranged at least partially within the space (24) and configured to collect the precipitation falling on the darkening surface (12).

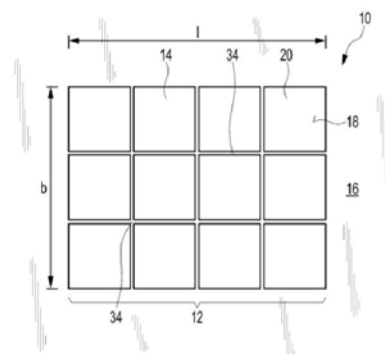

**Fig. 1**

**(56) Documents Cited :** WO 2009/135398 A1

RU 2071243 C1

CA 722429 A

## Patents Granted (Contd.)

FORM 25	(12) PATENT	(19) AP																		
<p><b>(11) Patent No :</b> AP 7840</p> <p><b>(21) Application No :</b> AP/P/2023/014702</p> <p><b>(22) Filing Date :</b> 16.02.2023</p> <p><b>(24) Date of Grant &amp; (45) Publication :</b> 31/07/2025</p>	<p><b>(73) Applicant(s)</b>                      ENHANCEDGEO HOLDINGS, LLC, 136 4th St. N., #344 St. Petersburg, FL 33701, United States of America</p> <p><b>(72) Inventors</b>                      CONNER Kimberly C, United States of America                      LINDBERG Greg, United States of America</p> <p><b>(74) Representative</b>                      ENSafrica Namibia, Namibia</p>	<p><b>(30) Priority Data</b></p> <table border="1" style="width: 100%; border-collapse: collapse;"> <thead> <tr> <th style="text-align: left;">(33) Country</th> <th style="text-align: left;">(31) Number</th> <th style="text-align: left;">(32) Date</th> </tr> </thead> <tbody> <tr> <td>US</td> <td>63/315063</td> <td>28.02.2022</td> </tr> <tr> <td>US</td> <td>18/099499</td> <td>20.01.2023</td> </tr> <tr> <td>US</td> <td>18/099509</td> <td>20.01.2023</td> </tr> <tr> <td>US</td> <td>18/099514</td> <td>20.01.2023</td> </tr> <tr> <td>US</td> <td>18/099518</td> <td>20.01.2023</td> </tr> </tbody> </table> <p><b>(84) Designated States:</b>                      KE RW TZ UG</p>	(33) Country	(31) Number	(32) Date	US	63/315063	28.02.2022	US	18/099499	20.01.2023	US	18/099509	20.01.2023	US	18/099514	20.01.2023	US	18/099518	20.01.2023
(33) Country	(31) Number	(32) Date																		
US	63/315063	28.02.2022																		
US	18/099499	20.01.2023																		
US	18/099509	20.01.2023																		
US	18/099514	20.01.2023																		
US	18/099518	20.01.2023																		
<p><b>(51) International Classification :</b> F24T 10/10 (2018.01)                      F24T 50/00 (2018.01)</p>		<p>F24T 10/30 (2018.01)                      F01K 21/00 (2018.01)</p>																		
<p><b>(54) Title</b>                      GEOTHERMAL POWER FROM SUPERHOT GEOTHERMAL FLUID AND MAGMA RESERVOIRS</p>																				
<p><b>(57) Abstract</b></p> <p>System, method, and apparatus for harnessing geothermal power from superhot geothermal fluid (SHGF) and magma reservoirs. An exemplary apparatus can include a well screen coupled to an end of a casing string. The well screen, which is at least partially submerged within an underground reservoir, defines a volume in the underground reservoir that can be filled with superhot geothermal fluid. A slidable casing is aligned coaxially with the well screen and configured to be repositioned relative to the well screen. A draw pipe extending through the slidable casing is configured to convey SHGF from the underground reservoir towards the surface in response to the slidable casing being repositioned to obstruct more of a set of apertures in the well screen and an increase in pressure within a cavity of the slidable casing.</p>																				
<p><b>(56) Documents Cited :</b> CN 108 952 650 A                      US 9,765,605 B2</p>																				
		<p>CN 113 494 273 A</p>																		
		<p>US 2013/0333383 A1</p>																		

## Classification Index of Granted Patents

IPC Symbol(s)	ARIPO Application No.	ARIPO Patent No.	PCT Application No.	Patentee's Name
G01N 33/24 (2006.01) G06Q 10/06 (2012.01)	AP/P/2023/015145	AP 7821	PCT/AU2022/050220	AUSTRALIAN NATURAL CAPITAL (IP) PTY LTD
G07D 7/00 (2016.01) G07D 7/12 (2016.01) G07D 7/20 (2016.01) G07D 7/0043 (2016.01) G07D 7/0047 (2016.01)	AP/P/2021/013732	AP 7832	PCT/EP2020/064812	SICPA HOLDING SA
G06Q 50/02 (2012.01) G06V 20/10 (2022.01) A01B 79/00 (2006.01) A01M 7/00 (2006.01)	AP/P/2023/015170	AP 7834	PCT/GB2022/050439	FARMSMARTER LTD.
G06F 3/01 (2006.01) G06F 3/16 (2006.01)	AP/P/2023/015411	AP 7830	PCT/JP2022/025199	HISHAB INDIA PRIVATE LIMITED
B01D 25/127 (2006.01) B01D 25/28 (2006.01) B01D 25/168 (2006.01) B01D 25/164 (2006.01) F16J 15/02 (2006.01) F16J 15/12 (2006.01)	AP/P/2022/014230	AP 7831	PCT/FI2020/050255	METSO FINLAND OY
G01N 21/00 (2006.01) B01J 13/00 (2006.01) B82Y 10/00 (2011.01) B82Y 20/00 (2011.01) B82Y 40/00 (2011.01) G01N 21/65 (2006.01)	AP/P/2022/013834	AP 7823	PCT/EP2020/069684	SICPA HOLDING SA
F24T 10/10 (2018.01) F24T 10/30 (2018.01) F24T 50/00 (2018.01) F01K 21/00 (2018.01)	AP/P/2023/014702	AP 7840		ENHANCEDGEO HOLDINGS, LLC
E01C 11/22 (2006.01) E03F 3/04 (2006.01) F16L 37/098 (2006.01) E03F 5/06 (2006.01)	AP/P/2021/013469	AP 7828	PCT/EP2019/063403	ACO AHLMANN SE & CO. KG.
H04W 76/19 (2018.01) H04W 52/02 (2009.01) H04W 36/00 (2009.01) H04W 76/15 (2018.01)	AP/P/2023/014615	AP 7824	PCT/SE2021/050718	TELEFONAKTIEBOLAGET LM ERICSSON (PUBL)
B65B 1/08 (2006.01) B65B 1/32 (2006.01) B65B 31/02 (2006.01)	AP/P/2021/013233	AP 7836	PCT/ES2019/070740	LABORATORIOS FARMACÉUTICOS ROVI, S. A.
A01K 67/033 (2006.01)	AP/P/2023/014895	AP 7820	PCT/EP2021/081962	INSECTUM APS
G01V 5/00 (2006.01) G01N 23/10 (2018.01)	AP/P/2023/015005	AP 7825	PCT/CN2021/138222	NUCTECH COMPANY LIMITED
E21B 17/02 (2006.01) E21B 17/042 (2006.01)	AP/P/2022/014565	AP 7833	PCT/EP2021/067808	SANDVIK MINING AND CONSTRUCTION TOOLS AB
B65D 41/34 (2006.01)	AP/P/2022/014379	AP 7838	PCT/US2020/058438	THISCAP, INC.
<b>H04W 8/20</b> (2009.01) <b>H04W 76/14</b> (2018.01) <b>H04W 4/80</b> (2018.01)	AP/U/2024/000254	AP/U/000060		BEIJING AN QI ZHI LIAN TECHNOLOGY CO., LTD.
G06T 11/00 (2006.01)	AP/P/2021/013713	AP 7837	PCT/IB2020/055977	UNIVERSITY OF JOHANNESBURG
A61M 5/28 (2006.01) A61J 1/06 (2006.01) A61M 5/32 (2006.01)	AP/P/2021/013185	AP 7835	PCT/JP2019/041116	KORTUC JAPAN LLC
H03K 17/00 (2006.01) H03K 17/94 (2006.01) B60R 25/021 (2013.01)	AP/P/2021/013632	AP 7829	PCT/IN2020/050566	BAJAJ AUTO LIMITED

## Classification Index of Granted Patents (Contd.)

IPC Symbol(s)	ARIPO Application No.	ARIPO Patent No.	PCT Application No.	Patentee's Name
B62M7/B62K11(2016.01) B62J43/B62K25(2016.01) B62K22B62K22(2016.01)	AP/P/2022/013933	AP 7826		MUSASHI SEIMITSU INDUSTRY CO., LTD.
B01D 5/00 (2006.01) A01G 15/00 (2006.01) F24S 20/40 (2018.01) F24S 20/60 (2018.01) F24S 21/00 (2018.01) F24S 25/12 (2018.01) F24S 40/44 (2018.01) F24S 70/275 (2018.01) F24S 20/00 (2018.01) F24S 80/00 (2018.01) E03B 3/02 (2006.01) E03B 3/28 (2006.01) H02S 20/10 (2014.01)	AP/P/2022/014563	AP 7839	PCT/EP2021/062852	UNIVERSITÄT HOHENHEIM
E02D 3/12 (2006.01) E02D 19/12 (2006.01) E02D 19/16 (2006.01) C09K 17/12 (2006.01)	AP/P/2022/014534	AP 7827	PCT/EP2020/062982	ROYAL EIJKELKAMP B.V.
A61K 9/00 (2006.01)	AP/P/2022/014001	AP 7822	PCT/US2020/054617	OAK CREST INSTITUTE OF SCIENCE

## Patentees' Name Index of Granted Patents

Patentee's Name	ARIPO Application No.	ARIPO Patent No.	PCT Application No.	IPC Symbol(s)
ACO AHLMANN SE & CO. KG.	AP/P/2021/013469	AP 7828	PCT/EP2019/063403	E01C 11/22 (2006.01) E03F 3/04 (2006.01) F16L 37/098 (2006.01) E03F 5/06 (2006.01)
TELEFONAKTIEBOLAGET LM ERICSSON (PUBL)	AP/P/2023/014615	AP 7824	PCT/SE2021/050718	H04W 76/19 (2018.01) H04W 52/02 (2009.01) H04W 36/00 (2009.01) H04W 76/15 (2018.01)
SICPA HOLDING SA	AP/P/2021/013732	AP 7832	PCT/EP2020/064812	G07D 7/00 (2016.01) G07D 7/12 (2016.01) G07D 7/20 (2016.01) G07D 7/0043 (2016.01) G07D 7/0047 (2016.01)
HISHAB INDIA PRIVATE LIMITED	AP/P/2023/015411	AP 7830	PCT/JP2022/025199	G06F 3/01 (2006.01) G06F 3/16 (2006.01)
FARMSMARTER LTD.	AP/P/2023/015170	AP 7834	PCT/GB2022/050439	G06Q 50/02 (2012.01) G06V 20/10 (2022.01) A01B 79/00 (2006.01) A01M 7/00 (2006.01)
METSO FINLAND OY	AP/P/2022/014230	AP 7831	PCT/FI2020/050255	B01D 25/127 (2006.01) B01D 25/28 (2006.01) B01D 25/168 (2006.01) B01D 25/164 (2006.01) F16J 15/02 (2006.01) F16J 15/12 (2006.01)
MUSASHI SEIMITSU INDUSTRY CO., LTD.	AP/P/2022/013933	AP 7826		B62M7/B62K11(2016.01) B62J43/B62K25(2016.01) B62K22/B62K22(2016.01)
SICPA HOLDING SA	AP/P/2022/013834	AP 7823	PCT/EP2020/069684	G01N 21/00 (2006.01) B01J 13/00 (2006.01) B82Y 10/00 (2011.01) B82Y 20/00 (2011.01) B82Y 40/00 (2011.01) G01N 21/65 (2006.01)
ENHANCEDGEO HOLDINGS, LLC	AP/P/2023/014702	AP 7840		F24T 10/10 (2018.01) F24T 10/30 (2018.01) F24T 50/00 (2018.01) F01K 21/00 (2018.01)
AUSTRALIAN NATURAL CAPITAL (IP) PTY LTD	AP/P/2023/015145	AP 7821	PCT/AU2022/050220	G01N 33/24 (2006.01) G06Q 10/06 (2012.01)
BEIJING AN QI ZHI LIAN TECHNOLOGY CO., LTD.	AP/U/2024/000254	AP/U/000060		<b>H04W 8/20</b> (2009.01) <b>H04W 76/14</b> (2018.01) <b>H04W 4/80</b> (2018.01)
UNIVERSITY OF JOHANNESBURG	AP/P/2021/013713	AP 7837	PCT/IB2020/055977	G06T 11/00 (2006.01)
KORTUC JAPAN LLC	AP/P/2021/013185	AP 7835	PCT/JP2019/041116	A61M 5/28 (2006.01) A61J 1/06 (2006.01) A61M 5/32 (2006.01)
INSECTUM APS	AP/P/2023/014895	AP 7820	PCT/EP2021/081962	A01K 67/033 (2006.01)
LABORATORIOS FARMACÉUTICOS ROVI, S. A.	AP/P/2021/013233	AP 7836	PCT/ES2019/070740	B65B 1/08 (2006.01) B65B 1/32 (2006.01) B65B 31/02 (2006.01)
BAJAJ AUTO LIMITED	AP/P/2021/013632	AP 7829	PCT/IN2020/050566	H03K 17/00 (2006.01) H03K 17/94 (2006.01) B60R 25/021 (2013.01)
NUCTECH COMPANY LIMITED	AP/P/2023/015005	AP 7825	PCT/CN2021/138222	G01V 5/00 (2006.01) G01N 23/10 (2018.01)
SANDVIK MINING AND CONSTRUCTION TOOLS AB	AP/P/2022/014565	AP 7833	PCT/EP2021/067808	E21B 17/02 (2006.01) E21B 17/042 (2006.01)

## Patentees' Name Index of Granted Patents (Contd.)

Patentee's Name	ARIPO Application No.	ARIPO Patent No.	PCT Application No.	IPC Symbol(s)
THISCAP, INC.	AP/P/2022/014379	AP 7838	PCT/US2020/058438	B65D 41/34 (2006.01)
OAK CREST INSTITUTE OF SCIENCE	AP/P/2022/014001	AP 7822	PCT/US2020/054617	A61K 9/00 (2006.01)
ROYAL EIJKELKAMP B.V.	AP/P/2022/014534	AP 7827	PCT/EP2020/062982	E02D 3/12 (2006.01) E02D 19/12 (2006.01) E02D 19/16 (2006.01) C09K 17/12 (2006.01)
UNIVERSITÄT HOHENHEIM	AP/P/2022/014563	AP 7839	PCT/EP2021/062852	B01D 5/00 (2006.01) A01G 15/00 (2006.01) F24S 20/40 (2018.01) F24S 20/60 (2018.01) F24S 21/00 (2018.01) F24S 25/12 (2018.01) F24S 40/44 (2018.01) F24S 70/275 (2018.01) F24S 20/00 (2018.01) F24S 80/00 (2018.01) E03B 3/02 (2006.01) E03B 3/28 (2006.01) H02S 20/10 (2014.01)

## ARIPO Application Number Index of Granted Patents

ARIPO Application No.	ARIPO Patent No.	PCT Application No.	Patentee's Name	IPC Symbol(s)
AP/P/2022/013933	AP 7826		MUSASHI SEIMITSU INDUSTRY CO., LTD.	B62M7/B62K11(2016.01) B62J43/B62K25(2016.01) B62K22B62K22(2016.01)
AP/P/2023/015145	AP 7821	PCT/AU2022/050220	AUSTRALIAN NATURAL CAPITAL (IP) PTY LTD	G01N 33/24 (2006.01) G06Q 10/06 (2012.01)
AP/P/2023/015170	AP 7834	PCT/GB2022/050439	FARMSMARTER LTD.	G06Q 50/02 (2012.01) G06V 20/10 (2022.01) A01B 79/00 (2006.01) A01M 7/00 (2006.01)
AP/P/2022/014230	AP 7831	PCT/FI2020/050255	METSO FINLAND OY	B01D 25/127 (2006.01) B01D 25/28 (2006.01) B01D 25/168 (2006.01) B01D 25/164 (2006.01) F16J 15/02 (2006.01) F16J 15/12 (2006.01)
AP/P/2021/013732	AP 7832	PCT/EP2020/064812	SICPA HOLDING SA	G07D 7/00 (2016.01) G07D 7/12 (2016.01) G07D 7/20 (2016.01) G07D 7/0043 (2016.01) G07D 7/0047 (2016.01)
AP/P/2023/015411	AP 7830	PCT/JP2022/025199	HISHAB INDIA PRIVATE LIMITED	G06F 3/01 (2006.01) G06F 3/16 (2006.01)
AP/U/2024/000254	AP/U/000060		BEIJING AN QI ZHI LIAN TECHNOLOGY CO., LTD.	<b>H04W 8/20</b> (2009.01) <b>H04W 76/14</b> (2018.01) <b>H04W 4/80</b> (2018.01)
AP/P/2021/013713	AP 7837	PCT/IB2020/055977	UNIVERSITY OF JOHANNESBURG	G06T 11/00 (2006.01)
AP/P/2021/013185	AP 7835	PCT/JP2019/041116	KORTUC JAPAN LLC	A61M 5/28 (2006.01) A61J 1/06 (2006.01) A61M 5/32 (2006.01)
AP/P/2022/014534	AP 7827	PCT/EP2020/062982	ROYAL EIJKELKAMP B.V.	E02D 3/12 (2006.01) E02D 19/12 (2006.01) E02D 19/16 (2006.01) C09K 17/12 (2006.01)
AP/P/2022/014563	AP 7839	PCT/EP2021/062852	UNIVERSITÄT HOHENHEIM	B01D 5/00 (2006.01) A01G 15/00 (2006.01) F24S 20/40 (2018.01) F24S 20/60 (2018.01) F24S 21/00 (2018.01) F24S 25/12 (2018.01) F24S 40/44 (2018.01) F24S 70/275 (2018.01) F24S 20/00 (2018.01) F24S 80/00 (2018.01) E03B 3/02 (2006.01) E03B 3/28 (2006.01) H02S 20/10 (2014.01)
AP/P/2021/013469	AP 7828	PCT/EP2019/063403	ACO AHLMANN SE & CO. KG.	E01C 11/22 (2006.01) E03F 3/04 (2006.01) F16L 37/098 (2006.01) E03F 5/06 (2006.01)
AP/P/2023/014615	AP 7824	PCT/SE2021/050718	TELEFONAKTIEBOLAGET LM ERICSSON (PUBL)	H04W 76/19 (2018.01) H04W 52/02 (2009.01) H04W 36/00 (2009.01) H04W 76/15 (2018.01)
AP/P/2023/014702	AP 7840		ENHANCEDGEO HOLDINGS, LLC	F24T 10/10 (2018.01) F24T 10/30 (2018.01) F24T 50/00 (2018.01) F01K 21/00 (2018.01)
AP/P/2022/013834	AP 7823	PCT/EP2020/069684	SICPA HOLDING SA	G01N 21/00 (2006.01) B01J 13/00 (2006.01) B82Y 10/00 (2011.01) B82Y 20/00 (2011.01) B82Y 40/00 (2011.01) G01N 21/65 (2006.01)

## ARIPO Application Number Index of Granted Patents (Contd.)

ARIPO Application No.	ARIPO Patent No.	PCT Application No.	Patentee's Name	IPC Symbol(s)
AP/P/2022/014565	AP 7833	PCT/EP2021/067808	SANDVIK MINING AND CONSTRUCTION TOOLS AB	E21B 17/02 (2006.01) E21B 17/042 (2006.01)
AP/P/2023/015005	AP 7825	PCT/CN2021/138222	NUCTECH COMPANY LIMITED	G01V 5/00 (2006.01) G01N 23/10 (2018.01)
AP/P/2022/014379	AP 7838	PCT/US2020/058438	THISCAP, INC.	B65D 41/34 (2006.01)
AP/P/2021/013233	AP 7836	PCT/ES2019/070740	LABORATORIOS FARMACÉUTICOS ROVI, S.A.	B65B 1/08 (2006.01) B65B 1/32 (2006.01) B65B 31/02 (2006.01)
AP/P/2023/014895	AP 7820	PCT/EP2021/081962	INSECTUM APS	A01K 67/033 (2006.01)
AP/P/2022/014001	AP 7822	PCT/US2020/054617	OAK CREST INSTITUTE OF SCIENCE	A61K 9/00 (2006.01)
AP/P/2021/013632	AP 7829	PCT/IN2020/050566	BAJAJ AUTO LIMITED	H03K 17/00 (2006.01) H03K 17/94 (2006.01) B60R 25/021 (2013.01)

## Patents Renewed

Patent No.	Application No.	Date Fee Paid	Valid Until	Anniversary
AP 2430	AP/P/2008/004313	14.07.2025	04.08.2026	19th yr
AP 2519	AP/P/2008/004319	28.07.2025	30.08.2026	19th yr
AP 2557	AP/P/2008/004330	14.07.2025	04.08.2026	19th yr
AP 2668	AP/P/2008/004332	14.07.2025	04.08.2026	19th yr
AP 2424	AP/P/2008/004348	03.07.2025	13.07.2026	19th yr
AP 2425	AP/P/2008/004349	03.07.2025	18.07.2026	19th yr
AP 2432	AP/P/2008/004364	14.07.2025	22.08.2026	19th yr
AP 2312	AP/P/2008/004371	18.07.2025	08.08.2026	19th yr
AP 5955	AP/P/2008/004469	02.07.2025	23.10.2026	19th yr
AP 2348	AP/P/2008/004473	22.07.2025	04.12.2025	18th yr
AP 3366	AP/P/2009/004973	16.07.2025	16.09.2026	16th yr
AP 2890	AP/P/2009/005096	22.06.2025	25.06.2026	17th yr
AP 3370	AP/P/2010/005135	11.07.2025	18.07.2026	17th yr
AP 5214	AP/P/2010/005140	08.07.2025	13.07.2026	18th yr
AP 2515	AP/P/2010/005161	24.07.2025	12.08.2026	17th yr
AP 3009	AP/P/2011/005560	07.07.2025	23.07.2026	16th yr
AP 3112	AP/P/2011/005632	18.07.2025	25.08.2026	16th yr
AP 3679	AP/P/2011/005750	04.07.2025	25.11.2026	16th yr
AP 3514	AP/P/2012/006095	11.07.2025	14.07.2026	15th yr
AP 4775	AP/P/2012/006124	09.07.2025	09.07.2026	15th yr
AP 4039	AP/P/2012/006163	14.07.2025	06.08.2026	15th yr
AP 3166	AP/P/2012/006211	23.07.2025	23.09.2026	15th yr
AP 3732	AP/P/2012/006367	30.06.2025	12.07.2026	13th yr
AP 3974	AP/P/2012/006451	24.07.2025	24.08.2026	13th yr
AP 3932	AP/P/2012/006645	27.06.2025	29.06.2026	14th yr
AP 3520	AP/P/2013/006703	28.07.2025	19.08.2026	14th yr
AP 3973	AP/P/2013/006709	30.06.2025	13.07.2026	14th yr
AP 3581	AP/P/2013/006730	14.07.2025	02.08.2026	14th yr
AP 3444	AP/P/2013/006770	28.07.2025	24.08.2026	14th yr
AP 3462	AP/P/2013/006778	14.07.2025	05.10.2026	13th yr
AP 3539	AP/P/2013/006782	28.07.2025	26.08.2026	14th yr
AP 4229	AP/P/2013/006791	25.07.2025	03.08.2026	14th yr
AP 3510	AP/P/2013/006848	18.07.2025	10.08.2026	14th yr
AP 5142	AP/P/2014/007366	27.06.2025	13.07.2026	13th yr
AP 4314	AP/P/2014/007385	27.06.2025	17.08.2026	13th yr
AP 4927	AP/P/2014/007399	28.07.2025	02.08.2026	13th yr
AP 4758	AP/P/2014/007404	30.06.2025	05.07.2026	14th yr
AP 3777	AP/P/2014/007413	30.06.2025	13.07.2026	13th yr

## Patents Renewed (Contd.)

Patent No.	Application No.	Date Fee Paid	Valid Until	Anniversary
AP 3992	AP/P/2014/007416	11.07.2025	16.07.2026	13th yr
AP 4317	AP/P/2014/007425	18.07.2025	08.08.2026	13th yr
AP 5911	AP/P/2014/007427	08.07.2025	19.07.2026	13th yr
AP 3639	AP/P/2014/007437	27.06.2025	15.08.2026	13th yr
AP 4533	AP/P/2014/007442	28.07.2025	09.08.2026	13th yr
AP 4150	AP/P/2014/007463	28.07.2025	17.08.2026	13th yr
AP 4618	AP/P/2014/007476	28.07.2025	15.08.2026	13th yr
AP 5206	AP/P/2014/007478	21.07.2025	27.07.2026	13th yr
AP 3937	AP/P/2014/007519	14.07.2025	17.08.2026	13th yr
AP 4493	AP/P/2014/007563	14.07.2025	07.09.2026	13th yr
AP 5192	AP/P/2014/007575	28.07.2025	14.09.2026	13th yr
AP 5625	AP/P/2014/007734	16.07.2025	19.12.2026	13th yr
AP 4777	AP/P/2014/008085	28.07.2025	22.08.2026	12th yr
AP 4423	AP/P/2015/008214	27.06.2025	04.07.2026	12th yr
AP 4341	AP/P/2015/008259	27.06.2025	05.07.2026	12th yr
AP 4424	AP/P/2015/008280	04.07.2025	02.08.2026	12th yr
AP 3765	AP/P/2015/008282	28.07.2025	09.08.2026	12th yr
AP 5617	AP/P/2015/008290	11.07.2025	26.08.2026	12th yr
AP 4674	AP/P/2015/008331	28.07.2025	30.08.2026	12th yr
AP 4569	AP/P/2015/008359	28.07.2025	02.08.2026	12th yr
AP 4733	AP/P/2015/008399	23.07.2025	23.09.2026	12th yr
AP 5181	AP/P/2015/008860	24.07.2025	28.07.2026	11th yr
AP 6775	AP/P/2015/008929	30.06.2025	12.07.2026	13th yr
AP 4947	AP/P/2015/008957	30.07.2025	25.06.2026	11th yr
AP 5034	AP/P/2015/008958	22.06.2025	01.07.2026	11th yr
AP 6547	AP/P/2016/008980	28.07.2025	04.08.2026	11th yr
AP 4992	AP/P/2016/008996	23.07.2025	25.07.2026	11th yr
AP 5027	AP/P/2016/009011	24.07.2025	31.07.2026	11th yr
AP 5811	AP/P/2016/009022	07.07.2025	17.07.2026	11th yr
AP 5009	AP/P/2016/009035	27.06.2025	11.08.2026	11th yr
AP 5194	AP/P/2016/009053	21.07.2025	21.07.2026	11th yr
AP 4743	AP/P/2016/009056	28.07.2025	19.08.2026	11th yr
AP 5204	AP/P/2016/009068	28.07.2025	05.08.2026	11th yr
AP 4776	AP/P/2016/009072	28.07.2025	10.09.2026	11th yr
AP 5866	AP/P/2016/009085	28.07.2025	15.08.2026	11th yr
AP 7004	AP/P/2016/009139	28.07.2025	15.09.2026	11th yr
AP 5231	AP/P/2016/009177	21.07.2025	30.09.2026	11th yr
AP 5258	AP/P/2016/009311	07.07.2025	01.07.2026	9th yr

## Patents Renewed (Contd.)

Patent No.	Application No.	Date Fee Paid	Valid Until	Anniversary
AP 4970	AP/P/2016/009351	11.07.2025	26.07.2026	9th yr
AP 4917	AP/P/2016/009466	11.07.2025	16.07.2026	13th yr
AP 7200	AP/P/2016/009490	22.06.2025	07.03.2026	10th yr
AP 6028	AP/P/2017/009685	07.07.2025	25.07.2026	10th yr
AP 5225	AP/P/2017/009718	28.07.2025	10.08.2026	10th yr
AP 5523	AP/P/2017/009720	07.07.2025	25.07.2026	11th yr
AP 6113	AP/P/2017/009730	18.07.2025	14.08.2026	10th yr
AP 5341	AP/P/2017/009732	16.07.2025	28.07.2026	10th yr
AP 5553	AP/P/2017/009746	07.07.2025	01.07.2026	10th yr
AP 5306	AP/P/2017/009748	28.07.2025	07.08.2026	10th yr
AP 5473	AP/P/2017/009761	04.07.2025	21.07.2026	10th yr
AP 5595	AP/P/2017/009763	14.07.2025	17.08.2026	10th yr
AP 5631	AP/P/2017/009765	14.07.2025	17.08.2026	10th yr
AP 5657	AP/P/2017/009788	14.07.2025	28.08.2026	10th yr
AP 5545	AP/P/2017/009807	28.07.2025	09.09.2026	10th yr
AP 5343	AP/P/2017/009863	23.07.2025	14.09.2026	10th yr
AP 6470	AP/P/2017/010045	27.06.2025	05.07.2026	8th yr
AP 5546	AP/P/2017/010100	08.07.2025	25.07.2026	8th yr
AP 6948	AP/P/2017/010134	14.07.2025	14.08.2026	8th yr
AP 5366	AP/P/2017/010311	08.07.2025	23.06.2026	9th yr
AP 6514	AP/P/2017/010392	22.06.2025	21.06.2026	9th yr
AP 5674	AP/P/2017/010414	01.07.2025	01.07.2026	9th yr
AP 5578	AP/P/2018/010419	27.06.2025	05.07.2026	9th yr
AP 5895	AP/P/2018/010427	03.07.2025	13.07.2026	9th yr
AP 5603	AP/P/2018/010447	27.06.2025	03.07.2026	10th yr
AP 5457	AP/P/2018/010451	22.07.2025	22.07.2026	9th yr
AP 5399	AP/P/2018/010452	22.07.2025	22.07.2026	9th yr
AP 5742	AP/P/2018/010464	27.06.2025	14.07.2026	9th yr
AP 5472	AP/P/2018/010478	30.06.2025	08.07.2026	10th yr
AP 7345	AP/P/2018/010483	27.06.2025	29.07.2026	9th yr
AP 6221	AP/P/2018/010493	27.06.2025	04.07.2026	9th yr
AP 5543	AP/P/2018/010495	27.06.2025	01.07.2026	9th yr
AP 5589	AP/P/2018/010508	04.07.2025	08.07.2026	9th yr
AP 6077	AP/P/2018/010512	16.07.2025	26.07.2026	9th yr
AP 6114	AP/P/2018/010514	28.07.2025	08.08.2026	9th yr
AP 5715	AP/P/2018/010520	21.07.2025	21.07.2026	9th yr
AP 5700	AP/P/2018/010528	28.07.2025	10.08.2026	9th yr
AP 6164	AP/P/2018/010539	21.07.2025	21.07.2026	9th yr

## Patents Renewed (Contd.)

Patent No.	Application No.	Date Fee Paid	Valid Until	Anniversary
AP 5682	AP/P/2018/010554	28.07.2025	01.09.2026	9th yr
AP 5405	AP/P/2018/010572	17.07.2025	19.07.2026	9th yr
AP 5717	AP/P/2018/010579	14.07.2025	19.08.2026	9th yr
AP 5994	AP/P/2018/010580	14.07.2025	19.08.2026	9th yr
AP 5983	AP/P/2018/010617	28.07.2025	25.08.2026	9th yr
AP 5677	AP/P/2018/010623	24.06.2025	04.08.2026	9th yr
AP 5613	AP/P/2018/010652	10.07.2025	15.09.2026	10th yr
AP 5907	AP/P/2018/010708	14.07.2025	18.10.2026	9th yr
AP 6382	AP/P/2018/010884	30.06.2025	16.03.2026	9th yr
AP 6019	AP/P/2018/010948	14.07.2025	14.08.2026	7th yr
AP 5958	AP/P/2018/010962	14.07.2025	23.08.2026	7th yr
AP 5506	AP/P/2018/011171	04.07.2025	03.08.2026	9th yr
AP 5463	AP/P/2018/011174	27.06.2025	03.08.2026	9th yr
AP 5449	AP/P/2018/011180	27.06.2025	03.08.2026	9th yr
AP 6397	AP/P/2018/011241	01.07.2025	05.07.2026	8th yr
AP 6196	AP/P/2019/011270	24.07.2025	07.08.2026	8th yr
AP 5848	AP/P/2019/011280	30.06.2025	14.07.2026	8th yr
AP 7201	AP/P/2019/011302	14.07.2025	01.08.2026	8th yr
AP 6145	AP/P/2019/011307	24.07.2025	25.07.2026	8th yr
AP 7124	AP/P/2019/011324	27.06.2025	26.07.2026	8th yr
AP 6408	AP/P/2019/011331	14.07.2025	15.08.2026	9th yr
AP 7674	AP/P/2019/011340	28.07.2025	08.08.2026	8th yr
AP 5829	AP/P/2019/011347	28.07.2025	18.08.2026	8th yr
AP 5494	AP/P/2019/011352	27.06.2025	17.08.2026	8th yr
AP 5561	AP/P/2019/011353	04.07.2025	25.08.2026	8th yr
AP 6747	AP/P/2019/011380	01.07.2025	26.08.2026	9th yr
AP 7697	AP/P/2019/011388	25.07.2025	03.08.2026	8th yr
AP 5558	AP/P/2019/011408	28.07.2025	31.08.2026	8th yr
AP 6395	AP/P/2019/011432	23.06.2025	04.08.2026	8th yr
AP 6787	AP/P/2019/011572	28.07.2025	21.08.2026	8th yr
AP 6940	AP/P/2019/011665	08.07.2025	22.08.2026	8th yr
AP 6353	AP/P/2019/011667	08.07.2025	02.08.2026	8th yr
AP 6424	AP/P/2019/011668	08.07.2025	29.08.2026	8th yr
AP 6272	AP/P/2019/011669	08.07.2025	29.08.2026	8th yr
AP 6416	AP/P/2019/011710	11.07.2025	16.07.2026	13th yr
AP 6438	AP/P/2019/011730	04.07.2025	29.08.2026	8th yr
AP 6288	AP/P/2019/011769	17.07.2025	15.02.2026	7th yr
AP 6307	AP/P/2019/011774	04.07.2025	24.01.2026	7th yr

## Patents Renewed (Contd.)

Patent No.	Application No.	Date Fee Paid	Valid Until	Anniversary
AP 6711	AP/P/2019/011889	15.07.2025	30.09.2026	6th yr
AP 6328	AP/P/2019/011930	23.06.2025	03.08.2026	7th yr
AP 6135	AP/P/2019/012066	15.07.2025	20.07.2026	8th yr
AP 6009	AP/P/2019/012098	03.07.2025	11.07.2026	7th yr
AP 6691	AP/P/2019/012104	11.07.2025	20.07.2026	7th yr
AP 6306	AP/P/2019/012105	11.07.2025	20.07.2026	7th yr
AP 6399	AP/P/2019/012107	11.07.2025	20.07.2026	7th yr
AP 6621	AP/P/2019/012109	11.07.2025	20.07.2026	7th yr
AP 6622	AP/P/2019/012110	11.07.2025	20.07.2026	7th yr
AP 6646	AP/P/2019/012111	22.06.2025	28.06.2026	7th yr
AP 6318	AP/P/2019/012113	03.07.2025	11.07.2026	7th yr
AP 5950	AP/P/2019/012114	03.07.2025	11.07.2026	7th yr
AP 6120	AP/P/2019/012132	01.07.2025	10.07.2026	7th yr
AP 6434	AP/P/2020/012170	14.07.2025	10.08.2026	8th yr
AP 6973	AP/P/2020/012178	04.07.2025	18.07.2026	7th yr
AP 6429	AP/P/2020/012180	28.07.2025	10.08.2026	7th yr
AP 6501	AP/P/2020/012188	24.07.2025	25.07.2026	7th yr
AP 6406	AP/P/2020/012192	16.07.2025	31.07.2026	7th yr
AP 6445	AP/P/2020/012194	16.07.2025	31.07.2026	7th yr
AP 6893	AP/P/2020/012198	07.07.2025	16.07.2026	7th yr
AP 6920	AP/P/2020/012200	25.07.2025	04.08.2026	8th yr
AP 6390	AP/P/2020/012202	03.07.2025	10.08.2026	7th yr
AP 6062	AP/P/2020/012204	27.06.2025	14.07.2026	7th yr
AP 6907	AP/P/2020/012208	14.07.2025	02.08.2026	7th yr
AP 6725	AP/P/2020/012209	27.06.2025	27.07.2026	7th yr
AP 6898	AP/P/2020/012210	30.06.2025	03.07.2026	7th yr
AP 6407	AP/P/2020/012213	28.07.2025	02.08.2026	7th yr
AP 6908	AP/P/2020/012215	14.07.2025	10.09.2026	7th yr
AP 6228	AP/P/2020/012216	07.07.2025	17.07.2026	7th yr
AP 6633	AP/P/2020/012217	04.07.2025	17.07.2026	7th yr
AP 6909	AP/P/2020/012220	07.07.2025	13.07.2026	7th yr
AP 6979	AP/P/2020/012275	18.07.2025	07.09.2026	7th yr
AP 6910	AP/P/2020/012287	16.07.2025	13.09.2026	7th yr
AP 6444	AP/P/2020/012305	17.07.2025	30.09.2026	8th yr
AP 6963	AP/P/2020/012439	16.07.2025	26.11.2026	7th yr
AP 6658	AP/P/2020/012443	28.07.2025	22.08.2026	7th yr
AP 6448	AP/P/2020/012465	21.07.2025	31.07.2026	6th yr
AP 6510	AP/P/2020/012492	01.07.2025	06.07.2026	7th yr

## Patents Renewed (Contd.)

Patent No.	Application No.	Date Fee Paid	Valid Until	Anniversary
AP 6712	AP/P/2020/012551	01.07.2025	15.07.2026	5th yr
AP 7250	AP/P/2020/012570	16.07.2025	31.07.2026	7th yr
AP 7508	AP/P/2020/012571	31.07.2025	01.02.2026	6th yr
AP 6431	AP/P/2020/012652	24.07.2025	24.09.2026	6th yr
AP 6999	AP/P/2020/012802	16.07.2025	25.07.2026	7th yr
AP 6977	AP/P/2020/012830	30.07.2025	17.06.2026	6th yr
AP 6930	AP/P/2020/012849	30.07.2025	17.06.2026	6th yr
AP 7075	AP/P/2020/012863	23.06.2025	22.10.2026	6th yr
AP 6990	AP/P/2020/012873	01.07.2025	02.07.2026	6th yr
AP 6967	AP/P/2020/012894	16.07.2025	18.07.2026	6th yr
AP 6738	AP/P/2021/012911	11.07.2025	11.07.2026	6th yr
AP 6723	AP/P/2021/012912	11.07.2025	11.07.2026	6th yr
AP 6359	AP/P/2021/012913	04.07.2025	25.08.2026	8th yr
AP 7187	AP/P/2021/012918	11.07.2025	13.07.2026	6th yr
AP 7385	AP/P/2021/012921	24.07.2025	19.07.2026	6th yr
AP 7474	AP/P/2021/012925	11.07.2025	22.07.2026	6th yr
AP 7657	AP/P/2021/012926	11.07.2025	22.07.2026	6th yr
AP 7311	AP/P/2021/012934	14.07.2025	02.08.2026	6th yr
AP 7450	AP/P/2021/012944	22.07.2025	22.07.2026	6th yr
AP 6942	AP/P/2021/012953	11.07.2025	18.07.2026	6th yr
AP 7451	AP/P/2021/012955	07.07.2025	22.07.2026	6th yr
AP 6859	AP/P/2021/012959	23.06.2025	15.07.2026	6th yr
AP 7403	AP/P/2021/012960	14.07.2025	07.08.2026	6th yr
AP 7036	AP/P/2021/012962	24.07.2025	26.07.2026	6th yr
AP 6945	AP/P/2021/012966	04.07.2025	15.07.2026	6th yr
AP 7280	AP/P/2021/012971	28.07.2025	01.08.2026	6th yr
AP 7386	AP/P/2021/012973	28.07.2025	08.08.2026	6th yr
AP 7650	AP/P/2021/012982	28.07.2025	01.08.2026	6th yr
AP 6875	AP/P/2021/012985	08.07.2025	15.07.2026	6th yr
AP 7043	AP/P/2021/012998	14.07.2025	05.08.2026	6th yr
AP 7407	AP/P/2021/013011	11.07.2025	15.07.2026	6th yr
AP 7422	AP/P/2021/013058	14.07.2025	28.08.2026	6th yr
AP 7434	AP/P/2021/013065	14.07.2025	07.08.2026	6th yr
AP 6771	AP/P/2021/013172	10.07.2025	28.11.2026	6th yr
AP 6745	AP/P/2021/013184	28.07.2025	16.08.2026	6th yr
AP 6739	AP/P/2021/013186	28.07.2025	16.08.2026	6th yr
AP 7106	AP/P/2021/013187	28.07.2025	16.08.2026	6th yr
AP 6740	AP/P/2021/013190	28.07.2025	16.08.2026	6th yr

## Patents Renewed (Contd.)

Patent No.	Application No.	Date Fee Paid	Valid Until	Anniversary
AP 7100	AP/P/2021/013193	04.07.2025	23.08.2026	8th yr
AP 7703	AP/P/2021/013225	27.06.2025	14.07.2026	9th yr
AP 7516	AP/P/2021/013236	14.07.2025	17.08.2026	10th yr
AP 7492	AP/P/2021/013260	16.07.2025	17.12.2026	6th yr
AP 7168	AP/P/2021/013346	08.07.2025	10.01.2026	5th yr
AP 7780	AP/P/2021/013452	08.07.2025	30.08.2026	4th yr
AP 7558	AP/P/2021/013456	16.07.2025	18.07.2026	6th yr
AP 7772	AP/P/2021/013569	01.07.2025	11.09.2026	6th yr
AP 7279	AP/P/2021/013602	14.07.2025	06.08.2026	4th yr
AP 7479	AP/P/2021/013707	11.07.2025	10.08.2026	5th yr
AP 7350	AP/P/2021/013722	01.07.2025	06.07.2026	5th yr
AP 7328	AP/P/2021/013733	01.07.2025	24.09.2026	5th yr
AP 7812	AP/P/2022/013738	16.07.2025	28.07.2026	5th yr
AP 7765	AP/P/2022/013747	27.06.2025	29.06.2026	5th yr
AP 7247	AP/P/2022/013752	21.07.2025	26.07.2026	6th yr
AP 7258	AP/P/2022/013755	01.07.2025	01.07.2026	5th yr
AP 7392	AP/P/2022/013772	09.07.2025	23.07.2026	5th yr
AP 6970	AP/P/2022/013799	30.06.2025	29.06.2026	5th yr
AP 7766	AP/P/2022/013801	30.06.2025	10.07.2026	5th yr
AP 7214	AP/P/2022/013808	01.07.2025	02.07.2026	5th yr
AP 7225	AP/P/2022/013862	11.06.2025	02.09.2026	5th yr
AP 7408	AP/P/2022/013927	28.07.2025	28.08.2026	5th yr
AP 7301	AP/P/2022/014098	14.07.2025	06.08.2026	4th yr
AP 7470	AP/P/2022/014244	07.07.2025	13.01.2026	4th yr
AP 7653	AP/P/2022/014522	11.07.2025	11.07.2026	6th yr
AP 7525	AP/P/2022/014547	15.07.2025	15.07.2026	5th yr
AP 7411	AP/P/2023/014660	25.07.2025	03.08.2026	4th yr
AP 7613	AP/P/2023/014716	18.07.2025	27.07.2026	4th yr
AP 7720	AP/P/2023/014807	08.07.2025	09.08.2026	4th yr
AP 7529	AP/P/2023/015049	14.07.2025	05.08.2026	6th yr

# UTILITY MODELS

## Utility Model Applications Filed

- (21) AP/U/2025/000275  
 (22) 04.07.2025  
 (23) 04.07.2025  
 (51) **C12Q 1/68 (2018.01)**  
**C12Q 1/6825 (2018.01)**  
**C12Q 1/6806 (2018.01)**  
**C12Q 1/6893 (2018.01)**  
**C12Q 1/6888 (2018.01)**  
**C12Q 1/6865 (2018.01)**  
 (54) DEVELOPMENT OF A CRISPR-LAMP BASED BIOSENSOR WITH A LATERAL FLOW READOUT FOR THE DETECTION OF CUTANEOUS LEISHMANIASIS  
 (74) Basing Wihibeturo Laud Anthony  
 (75) BASING Laud Anthony  
 (84) GH, KE, RW  
 (96) 04.07.2025 AP/U/2025/000275
- ●
- (21) AP/U/2025/000276  
 (22) 07.07.2025  
 (23) 07.07.2025  
 (51) **G01N 31/22 (2006.01)**  
**G01N 33/03 (2006.01)**  
**G01N 33/28 (2006.01)**  
 (54) DEVELOPMENT OF A RAPID TEST FOR THE DETECTION OF SUDAN IV IN PALM OIL  
 (74) Basing Wihibeturo Laud Anthony  
 (75) BASING Laud Anthony  
 (84) CV, GH, KE  
 (96) 07.07.2025 AP/U/2025/000276
- ●
- 

## Utility Model Applications Abandoned

- (21) AP/U/2020/000175  
 (22) 22.01.2020  
 (23) 22.07.2022  
 (51) **C12M 1/02 (2006.01)**  
**C12P 7/10 (2006.01)**  
**C12N 11/14 (2006.01)**  
 (54) ELECTRICITY FROM LIVING WATER HYACINTH PLANTS ENHANCED BIOGAS PRODUCTION  
 (74) CHIRARA Tawanda Macdonald  
 (75) CHIRARA Tawanda Macdonald  
 (84) ZW
- ●
- (21) AP/U/2022/000206  
 (22) 22.02.2022  
 (23) 22.08.2023  
 (51) **A61L 15/22 (2006.01)**  
**A61L 15/26 (2016.01)**  
**A61L 15/28 (2006.01)**  
**A61L 15/16 (2006.01)**  
**A61L 15/20 (2006.01)**  
**A61L 15/10 (2006.01)**  
**A61L 15/12 (2006.01)**  
**A61L 15/00 (2006.01)**  
 (54) HIGHLY ABSORBENT MATERIAL FOR BIODEGRADABLE HYGIENE PRODUCTS  
 (74) KEMUNTO MOTURI AND ASSOCIATES LLP  
 (75) KINYANJUI Joseph and MUREITHI Nyaruai Mary  
 (84) BW, GH, GM, KE, LR, LS, MW, MZ, NA, RW, SD, SL, ST, SZ, TZ, UG, ZM, ZW
- ●
- 

## Utility Model Applications Pending Registration

- (21) AP/U/2023/000245  
 (22) 30.06.2021  
 (23) 07.07.2025  
 (51) **F16K 1/52 (2023.01)**  
**F16K 31/50 (2023.01)**  
**F16K 1/00 (2023.01)**  
**F16K 1/42 (2023.01)**  
**F16K 1/46 (2023.01)**  
**F16K 1/48 (2023.01)**  
 (54) VALVE  
 (74) ADAMS AND ADAMS MOZAMBIQUE  
 (84) BW, GH, GM, KE, LR, LS, MW, MZ, NA, RW, SD, SL, ST, SZ, TZ, UG, ZM, ZW
- ●
- (21) AP/U/2024/000249  
 (22) 21.03.2024  
 (23) 10.07.2025  
 (51) **G06Q 30/06 (2023.01)**  
**G06K 19/06 (2006.01)**  
**G06Q 20/00 (2012.01)**  
 (54) RECHARGING AIRTIME THROUGH QR CODE SCANNING  
 (74) MAHLANGU Nkosilathi Enock  
 (84) ZW
- ●
-

## Utility Model Applications Renewed

<b>Application No.</b>	<b>Date Fee Paid</b>	<b>Valid Until</b>	<b>Anniversary</b>
AP/U/2023/000242	23.06.2025	28.08.2026	2nd yr

## Utility Models Registered

FORM 25	(12) PATENT	(19) AP																					
<p><b>(11) Patent No :</b> AP/U/000060</p> <p><b>(21) Application No :</b> AP/U/2024/000254</p> <p><b>(22) Filing Date :</b> 07.04.2022</p> <p><b>(24) Date of Grant &amp; (45) Publication :</b> 03/07/2025</p>	<p><b>(73) Applicant(s)</b> BEIJING AN QI ZHI LIAN TECHNOLOGY CO., LTD., 31 on 2F, Building 20, Tian Xi Yuan, Chao Yang District, Beijing, China</p>																						
<p><b>(30) Priority Data</b></p> <table style="width: 100%; border-collapse: collapse;"> <thead> <tr> <th style="text-align: left;">(33) Country</th> <th style="text-align: left;">(31) Number</th> <th style="text-align: left;">(32) Date</th> </tr> </thead> <tbody> <tr> <td> </td> <td> </td> <td> </td> </tr> </tbody> </table>	(33) Country	(31) Number	(32) Date				<p><b>(72) Inventors</b> TIANPENG Jiang, Peoples Republic of China</p>																
(33) Country	(31) Number	(32) Date																					
<p><b>(84) Designated States:</b></p> <table style="width: 100%; border-collapse: collapse;"> <tbody> <tr> <td>BW</td><td>GH</td><td>GM</td><td>KE</td><td>LR</td><td>LS</td><td>MW</td> </tr> <tr> <td>MZ</td><td>NA</td><td>RW</td><td>SC</td><td>SD</td><td>SL</td><td>ST</td> </tr> <tr> <td>SZ</td><td>TZ</td><td>UG</td><td>ZM</td><td>ZW</td><td> </td><td> </td> </tr> </tbody> </table>	BW	GH	GM	KE	LR	LS	MW	MZ	NA	RW	SC	SD	SL	ST	SZ	TZ	UG	ZM	ZW			<p><b>(74) Representative</b> OTSWONG'O Omukubi Fredrick, Kenya</p>	
BW	GH	GM	KE	LR	LS	MW																	
MZ	NA	RW	SC	SD	SL	ST																	
SZ	TZ	UG	ZM	ZW																			

**(51) International Classification :** **H04W 8/20** (2009.01) **H04W 76/14** (2018.01)  
**H04W 4/80** (2018.01)

**(54) Title**  
SYSTEM AND METHOD FOR AD GENERATION ON A PEER TO PEER NETWORK

**(57) Abstract**

The present invention relates to an advertising generation in peer to peer networks, comprising a server with a storage device and memory, a first network, and at least a first and second devices capable of engaging in a peer to peer network, preferably via Bluetooth or Wi-Fi. Said server being able to maintain a list of ad content in its storage device or memory, and is capable of transmitting via a first network said list of ad content to at least a device capable of initiating and maintaining a peer to peer network. The first device receives said list of ad content, generates a list of share-able material from material available on memory or storage and received list, and transmits in ad format said material in said share-able list to second device if said material is unavailable on second device.

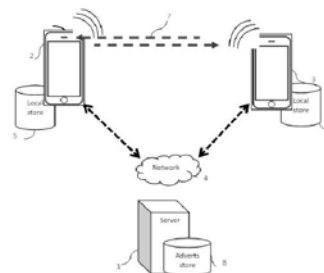

FIG. 1

**(56) Documents Cited :**

## Utility Models Renewed

<b>Patent No.</b>	<b>Application No.</b>	<b>Date Fee Paid</b>	<b>Valid Until</b>	<b>Anniversary</b>
AP/U/000025	AP/U/2018/000132	24.06.2025	28.08.2026	7th yr
AP/U/000026	AP/U/2018/000133	24.06.2025	28.08.2026	7th yr
AP/U/000028	AP/U/2018/000131	24.06.2025	28.08.2026	7th yr
AP/U/000029	AP/U/2018/000134	24.06.2025	28.08.2026	7th yr

# DESIGNS

## Design Applications Filed

- (21) AP/D/2025/002018  
 (22) 03.07.2025  
 (51) **20-03**  
 (54) MY GIRL TEA DOUBLE LAYER PROTECTION LABEL  
 (71) GUANGDONG BORDAR TECHNOLOGY CO. LTD  
 (72) JIANG Zoey  
 (74) NHM ADVOCATES  
 (84) BW, CV, GH, GM, KE, LR, LS, MW, MZ, NA, RW, SC, SD, SL, ST, SZ, TZ, UG, ZM, ZW

● ●

- (21) AP/D/2025/002019  
 (22) 22.07.2025  
 (51) **12-14**  
 (54) PHOTOVOLTAIC ELECTRIC VEHICLE  
 (71) SOLARKY MOBILITY TECHNOLOGIES CO., LTD.  
 (72) SHAO Jiayi, LI He, WANG Xiaohui, et al  
 (74) HONEY & BLANCKENBERG  
 (84) TZ

● ●

■

## Design Applications Lapsed

- (11) AP/D/00781  
 (21) AP/D/2015/001001  
 (22) 11.06.2015  
 (51) **03-01**  
 (54) PORTABLE TERMINAL  
 (71) SAMSUNG ELECTRONICS CO., LTD.  
 (72) YEO Hongku, CHOI Hyoksu, LEE Minhyouk, et al  
 (74) ADAMS AND ADAMS MOZAMBIQUE  
 (84) BW, GH, GM, KE, LR, LS, MW, MZ, NA, RW, SD, SL, ST, SZ, TZ, UG, ZM, ZW

● ●

- (11) AP/D/00782  
 (21) AP/D/2015/001003  
 (22) 11.06.2015  
 (51) **14-03**  
 (54) PORTABLE TERMINAL  
 (71) SAMSUNG ELECTRONICS CO., LTD.  
 (72) CHOI Hyoksu, YEO Hongku, LEE Minhyouk, et al  
 (74) ADAMS AND ADAMS MOZAMBIQUE  
 (84) BW, GH, GM, KE, LR, LS, MW, MZ, NA, RW, SD, SL, ST, SZ, TZ, UG, ZM, ZW

● ●

- (11) AP/D/00868  
 (21) AP/D/2015/001037  
 (22) 14.07.2015  
 (51) **09-01**  
 (54) NAPHTHALENE BALL / INSECT REPELLENT  
 (71) OM SATNAM LIMITED  
 (72) MIRPURI S K  
 (74) OM SATNAM LIMITED  
 (84) GH, LR, SL

● ●

- (11) AP/D/00869  
 (21) AP/D/2015/001038  
 (22) 14.07.2015  
 (51) **09-01**  
 (54) AIR FRESHENER / INSECT REPELLENT  
 (71) OM SATNAM LIMITED  
 (72) MIRPURI S K  
 (74) OM SATNAM LIMITED  
 (84) GH, LR, SL

● ●

■

## Design Applications Renewed

<b>Application No.</b>	<b>Date Fee Paid</b>	<b>Valid Until</b>	<b>Anniversary</b>
AP/D/2019/001392	21.07.2025	05.08.2026	6th yr
AP/D/2019/001393	21.07.2025	05.08.2026	6th yr
AP/D/2024/001925	16.07.2025	07.08.2026	1st yr
AP/D/2024/001930	28.07.2025	23.08.2026	1st yr
AP/D/2024/001931	28.07.2025	23.08.2026	1st yr
AP/D/2024/001932	28.07.2025	23.08.2026	1st yr
AP/D/2024/001933	28.07.2025	23.08.2026	1st yr

## Designs Registered

FORM 25	(12) DESIGN	(19) AP/D																											
<p>(11) <b>Design No :</b> AP/D/01598</p> <p>(21) <b>Application No :</b> AP/D/2024/001926</p> <p>(22) <b>Filing Date :</b> 07.08.2024</p> <p>(24) <b>Registration Date:</b> 04/07/2025</p>	<p><b>(73) Applicant(s)</b>                      BATHU SWAG (PTY) LIMITED, Bathu Headquarters, Unit 4 Sterling Industrial Park, Sterling Road, Olievenhoutbosch, 0187, Gauteng, South Africa</p> <p><b>(72) Creators</b>                      LEKALAKALA Itumeleng, South Africa                      REAMOGETSWE Theophilus Baloyi, South Africa                      MOKGATLANE Ofentse Phineas, South Africa</p> <p><b>(74) Representative</b>                      ADAMS AND ADAMS MOZAMBIQUE, Mozambique</p>	<p><b>(30) Priority Data</b></p> <table style="width: 100%; border-collapse: collapse;"> <thead> <tr> <th style="text-align: left;">(33) Country</th> <th style="text-align: left;">(31) Number</th> <th style="text-align: left;">(32) Date</th> </tr> </thead> <tbody> <tr> <td> </td> <td> </td> <td> </td> </tr> </tbody> </table> <p><b>(84) Designated States:</b></p> <table style="width: 100%; border-collapse: collapse;"> <tbody> <tr> <td>BW</td> <td>CV</td> <td>GH</td> <td>GM</td> <td>KE</td> <td>LR</td> <td>LS</td> </tr> <tr> <td>MW</td> <td>MZ</td> <td>NA</td> <td>RW</td> <td>SC</td> <td>SD</td> <td>SL</td> </tr> <tr> <td>ST</td> <td>SZ</td> <td>TZ</td> <td>UG</td> <td>ZM</td> <td>ZW</td> <td> </td> </tr> </tbody> </table>	(33) Country	(31) Number	(32) Date				BW	CV	GH	GM	KE	LR	LS	MW	MZ	NA	RW	SC	SD	SL	ST	SZ	TZ	UG	ZM	ZW	
(33) Country	(31) Number	(32) Date																											
BW	CV	GH	GM	KE	LR	LS																							
MW	MZ	NA	RW	SC	SD	SL																							
ST	SZ	TZ	UG	ZM	ZW																								
<p>(51) <b>International Classification :</b> 02-04</p>																													
<p>(54) <b>Title</b> FOOTWEARS</p>																													

FIGURE 1



Three-dimensional view from front

## Designs Registered (Contd.)

FORM 25	(12) DESIGN	(19) AP/D						
<p>(11) Design No : AP/D/01599</p> <p>(21) Application No : AP/D/2024/001950</p> <p>(22) Filing Date : 27.09.2024</p> <p>(24) Registration Date: 04/07/2025</p>	<p>(73) Applicant(s) CHERY AUTOMOBILE CO., LTD., No. 8 Changchun Road, Economy &amp; Technology Development Zone, Wuhu, Anhui 241006, China</p>	<p>(72) Creators GAO Xinhua, Peoples Republic of China</p>						
<p>(30) Priority Data</p> <table style="width: 100%; border-collapse: collapse;"> <tr> <td style="width: 33%;">(33) Country</td> <td style="width: 33%;">(31) Number</td> <td style="width: 34%;">(32) Date</td> </tr> <tr> <td>CN</td> <td>2024301721223</td> <td>29.03.2024</td> </tr> </table>	(33) Country	(31) Number	(32) Date	CN	2024301721223	29.03.2024	<p>(74) Representative ADAMS AND ADAMS MOZAMBIQUE, Mozambique</p>	
(33) Country	(31) Number	(32) Date						
CN	2024301721223	29.03.2024						
<p>(84) Designated States: SD</p>								
<p>(51) International Classification : 12-08</p>								
<p>(54) Title AUTOMOBILE</p>								



Figure 1  
Three-dimensional view

## Designs Registered (Contd.)

FORM 25	(12) DESIGN	(19) AP/D						
<p>(11) Design No : AP/D/01600</p> <p>(21) Application No : AP/D/2024/001958</p> <p>(22) Filing Date : 17.10.2024</p> <p>(24) Registration Date: 04/07/2025</p>	<p><b>(73) Applicant(s)</b> 180 DEGREES MARKETING (PTY) LTD, Corner Searle and Pontac Streets, Cape Town, Western Cape, 8001, South Africa</p>							
<p>(30) Priority Data</p> <table style="width: 100%; border-collapse: collapse;"> <tr> <td style="width: 33%;">(33) Country</td> <td style="width: 33%;">(31) Number</td> <td style="width: 33%;">(32) Date</td> </tr> <tr> <td>ZA</td> <td>A2024/00390</td> <td>24.04.2024</td> </tr> </table>	(33) Country	(31) Number	(32) Date	ZA	A2024/00390	24.04.2024	<p><b>(72) Creators</b> ANDRÉ David Ellis, South Africa MATHIESEN Brian Arthur, South Africa</p>	
(33) Country	(31) Number	(32) Date						
ZA	A2024/00390	24.04.2024						
<p>(84) Designated States:</p> <p style="text-align: center;">BW KE LS NA SZ TZ ZM ZW</p>	<p><b>(74) Representative</b> ROLAND INTELLECTUAL PROPERTY CONSULTANTS, Namibia</p>							
<p>(51) International Classification : 14-04</p>								
<p>(54) Title SCREEN DISPLAY</p>								



FIG. 1: FRONT VIEW OF A DISPLAY SCREEN OR A PORTION THEREOF WITH A GRAPHICAL USER INTERFACE

## Designs Registered (Contd.)

FORM 25	(12) DESIGN	(19) AP/D																					
<p>(11) Design No : AP/D/01601</p> <p>(21) Application No : AP/D/2024/001898</p> <p>(22) Filing Date : 30.05.2024</p> <p>(24) Registration Date: 10/07/2025</p>	<p>(73) Applicant(s) WAEV INC., 2114 West Ball Road, Anaheim, California 92804, United States of America</p>	<p>(72) Creators KENNEY James Joseph, United States of America</p>																					
<p>(30) Priority Data</p> <table style="width: 100%; border-collapse: collapse;"> <thead> <tr> <th style="text-align: left;">(33) Country</th> <th style="text-align: left;">(31) Number</th> <th style="text-align: left;">(32) Date</th> </tr> </thead> <tbody> <tr> <td>US</td> <td>29/920,87</td> <td>13.12.2023</td> </tr> </tbody> </table>	(33) Country	(31) Number	(32) Date	US	29/920,87	13.12.2023	<p>(74) Representative B. W. KAHARI LEGAL PRACTITIONERS, Zimbabwe</p>																
(33) Country	(31) Number	(32) Date																					
US	29/920,87	13.12.2023																					
<p>(84) Designated States:</p> <table style="width: 100%; border-collapse: collapse;"> <tbody> <tr> <td>BW</td><td>CV</td><td>GH</td><td>GM</td><td>KE</td><td>LR</td><td>LS</td> </tr> <tr> <td>MW</td><td>MZ</td><td>NA</td><td>RW</td><td>SC</td><td>SD</td><td>SL</td> </tr> <tr> <td>ST</td><td>SZ</td><td>TZ</td><td>UG</td><td>ZM</td><td>ZW</td><td></td> </tr> </tbody> </table>	BW	CV	GH	GM	KE	LR	LS	MW	MZ	NA	RW	SC	SD	SL	ST	SZ	TZ	UG	ZM	ZW			
BW	CV	GH	GM	KE	LR	LS																	
MW	MZ	NA	RW	SC	SD	SL																	
ST	SZ	TZ	UG	ZM	ZW																		
<p>(51) International Classification : 12-13</p>																							
<p>(54) Title UTILITY VEHICLE</p>																							

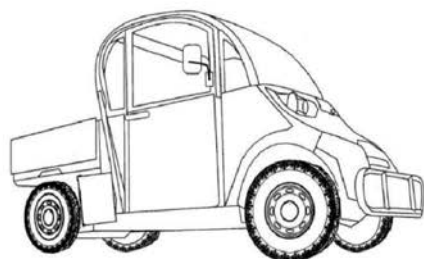

**FIGURE 3: Right side perspective view thereof  
looking vehicle rearward from the front**

## Designs Registered (Contd.)

FORM 25	(12) DESIGN	(19) AP/D																					
<p><b>(11) Design No :</b> AP/D/01602</p> <p><b>(21) Application No :</b> AP/D/2024/001944</p> <p><b>(22) Filing Date :</b> 12.09.2024</p> <p><b>(24) Registration Date:</b> 10/07/2025</p>	<p><b>(73) Applicant(s)</b> JIANGMEN DACHANGJIANG GROUP CO., LTD., No. 5, Jiandabei Road, Jiangmen City, Guangdong Province, 529000, China</p>	<p><b>(72) Creators</b> FAN Peiyong, Peoples Republic of China</p>																					
<p><b>(30) Priority Data</b></p> <table style="width: 100%; border-collapse: collapse;"> <tr> <td style="text-align: center;"><b>(33) Country</b></td> <td style="text-align: center;"><b>(31) Number</b></td> <td style="text-align: center;"><b>(32) Date</b></td> </tr> </table>	<b>(33) Country</b>	<b>(31) Number</b>	<b>(32) Date</b>	<p><b>(74) Representative</b> INVENTA MOZAMBIQUE, LDA., Mozambique</p>																			
<b>(33) Country</b>	<b>(31) Number</b>	<b>(32) Date</b>																					
<p><b>(84) Designated States:</b></p> <table style="width: 100%; border-collapse: collapse;"> <tr> <td style="text-align: center;">BW</td> <td style="text-align: center;">CV</td> <td style="text-align: center;">GH</td> <td style="text-align: center;">GM</td> <td style="text-align: center;">KE</td> <td style="text-align: center;">LR</td> <td style="text-align: center;">LS</td> </tr> <tr> <td style="text-align: center;">MW</td> <td style="text-align: center;">NA</td> <td style="text-align: center;">RW</td> <td style="text-align: center;">SC</td> <td style="text-align: center;">SD</td> <td style="text-align: center;">SL</td> <td style="text-align: center;">ST</td> </tr> <tr> <td style="text-align: center;">SZ</td> <td style="text-align: center;">TZ</td> <td style="text-align: center;">UG</td> <td style="text-align: center;">ZM</td> <td style="text-align: center;">ZW</td> <td></td> <td></td> </tr> </table>	BW	CV	GH	GM	KE	LR	LS	MW	NA	RW	SC	SD	SL	ST	SZ	TZ	UG	ZM	ZW				
BW	CV	GH	GM	KE	LR	LS																	
MW	NA	RW	SC	SD	SL	ST																	
SZ	TZ	UG	ZM	ZW																			
<p><b>(51) International Classification :</b> 12-11</p>																							
<p><b>(54) Title</b> MOTORCYCLE</p>																							



## Designs Registered (Contd.)

FORM 25	(12) DESIGN	(19) AP/D
<p>(11) Design No : AP/D/01603</p> <p>(21) Application No : AP/D/2024/001946</p> <p>(22) Filing Date : 19.09.2024</p> <p>(24) Registration Date: 10/07/2025</p>	<p>(73) Applicant(s) CEAT LIMITED, RPG House,463, Dr. Annie Besant Road, Worli, Mumbai, 400030, India</p>	<p>(72) Creators PARMAR Ajaykumar, India</p>
<p>(30) Priority Data (33) Country (31) Number (32) Date</p>	<p>(74) Representative HUSSEIN &amp; Co., Zimbabwe</p>	
<p>(84) Designated States: UG</p>		
<p>(51) International Classification : 12-15</p>		
<p>(54) Title TYRE</p>		



## Designs Registered (Contd.)

FORM 25	(12) DESIGN	(19) AP/D						
<p><b>(11) Design No :</b> AP/D/01604</p> <p><b>(21) Application No :</b> AP/D/2024/001914</p> <p><b>(22) Filing Date :</b> 05.08.2024</p> <p><b>(24) Registration Date:</b> 18/07/2025</p>	<p><b>(73) Applicant(s)</b> BEIERSDORF AG, Beiersdorfstrasse 1-9, 22529 Hamburg, Germany</p>	<p><b>(72) Creators</b> MÄHLMANN Kurt, Germany WIRTH Cristin, Germany CAU Stéfane, Germany</p>						
<p><b>(30) Priority Data</b></p> <table style="width: 100%; border-collapse: collapse;"> <tr> <td style="width: 33%;"><b>(33) Country</b></td> <td style="width: 33%;"><b>(31) Number</b></td> <td style="width: 33%;"><b>(32) Date</b></td> </tr> <tr> <td>IB</td> <td>DM/238256</td> <td>26.06.2024</td> </tr> </table>	<b>(33) Country</b>	<b>(31) Number</b>	<b>(32) Date</b>	IB	DM/238256	26.06.2024	<p><b>(74) Representative</b> ADAMS AND ADAMS MOZAMBIQUE, Mozambique</p>	
<b>(33) Country</b>	<b>(31) Number</b>	<b>(32) Date</b>						
IB	DM/238256	26.06.2024						
<p><b>(84) Designated States:</b> KE TZ UG</p>								

**(51) International Classification :** 32-01

**(54) Title**  
GRAPHIC DESIGN



Single Figure  
Front view

## Designs Registered (Contd.)

FORM 25	(12) DESIGN	(19) AP/D						
<p>(11) Design No : AP/D/01605</p> <p>(21) Application No : AP/D/2024/001915</p> <p>(22) Filing Date : 05.08.2024</p> <p>(24) Registration Date: 18/07/2025</p>	<p>(73) Applicant(s) BEIERSDORF AG, Beiersdorfstrasse 1-9, 22529 Hamburg, Germany</p>	<p>(72) Creators MÄHLMANN Kurt, Germany WIRTH Cristin, Germany CAU Stéfane, Germany</p>						
<p>(30) Priority Data</p> <table style="width: 100%; border-collapse: collapse;"> <tr> <td style="width: 33%;">(33) Country</td> <td style="width: 33%;">(31) Number</td> <td style="width: 33%;">(32) Date</td> </tr> <tr> <td>IB</td> <td>DM/238256</td> <td>26.06.2024</td> </tr> </table>	(33) Country	(31) Number	(32) Date	IB	DM/238256	26.06.2024	<p>(74) Representative ADAMS AND ADAMS MOZAMBIQUE, Mozambique</p>	
(33) Country	(31) Number	(32) Date						
IB	DM/238256	26.06.2024						
<p>(84) Designated States: KE TZ UG</p>								

(51) International Classification : 32-01

(54) Title  
GRAPHIC DESIGN



Single Figure  
Front view

## Designs Registered (Contd.)

FORM 25	(12) DESIGN	(19) AP/D						
<p>(11) Design No : AP/D/01606</p> <p>(21) Application No : AP/D/2024/001916</p> <p>(22) Filing Date : 05.08.2024</p> <p>(24) Registration Date: 18/07/2025</p>	<p>(73) Applicant(s) BEIERSDORF AG, Beiersdorfstrasse 1-9, 22529 Hamburg, Germany</p>	<p>(72) Creators MÄHLMANN Kurt, Germany CAU Stéfane, Germany WIRTH Cristin, Germany</p>						
<p>(30) Priority Data</p> <table style="width: 100%; border-collapse: collapse;"> <tr> <td style="width: 33%;">(33) Country</td> <td style="width: 33%;">(31) Number</td> <td style="width: 33%;">(32) Date</td> </tr> <tr> <td>IB</td> <td>DM/238256</td> <td>26.06.2024</td> </tr> </table>	(33) Country	(31) Number	(32) Date	IB	DM/238256	26.06.2024	<p>(74) Representative ADAMS AND ADAMS MOZAMBIQUE, Mozambique</p>	
(33) Country	(31) Number	(32) Date						
IB	DM/238256	26.06.2024						
<p>(84) Designated States: KE TZ UG</p>								
<p>(51) International Classification : 32-01</p>								
<p>(54) Title GRAPHIC DESIGN</p>								



## Designs Registered (Contd.)

FORM 25	(12) DESIGN	(19) AP/D						
<p>(11) <b>Design No :</b> AP/D/01607</p> <p>(21) <b>Application No :</b> AP/D/2024/001917</p> <p>(22) <b>Filing Date :</b> 05.08.2024</p> <p>(24) <b>Registration Date:</b> 18/07/2025</p>	<p>(73) <b>Applicant(s)</b> BEIERSDORF AG, Beiersdorfstrasse 1-9, 22529 Hamburg, Germany</p>	<p>(72) <b>Creators</b> WIRTH Cristin, Germany CAU Stéfane, Germany MÄHLMANN Kurt, Germany</p>						
<p>(30) <b>Priority Data</b></p> <table style="width: 100%; border-collapse: collapse;"> <tr> <td style="width: 33%;"><b>(33) Country</b></td> <td style="width: 33%;"><b>(31) Number</b></td> <td style="width: 33%;"><b>(32) Date</b></td> </tr> <tr> <td>IB</td> <td>DM/238256</td> <td>26.06.2024</td> </tr> </table>	<b>(33) Country</b>	<b>(31) Number</b>	<b>(32) Date</b>	IB	DM/238256	26.06.2024	<p>(74) <b>Representative</b> ADAMS AND ADAMS MOZAMBIQUE, Mozambique</p>	
<b>(33) Country</b>	<b>(31) Number</b>	<b>(32) Date</b>						
IB	DM/238256	26.06.2024						
<p>(84) <b>Designated States:</b> KE TZ UG</p>								

(51) **International Classification :** 32-01

(54) **Title**  
GRAPHIC DESIGN

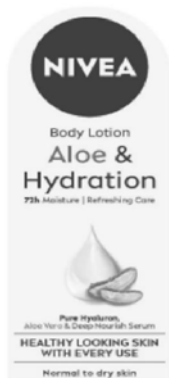

Single Figure  
Front view

## Designs Registered (Contd.)

FORM 25	(12) DESIGN	(19) AP/D						
<p>(11) <b>Design No :</b> AP/D/01608</p> <p>(21) <b>Application No :</b> AP/D/2024/001918</p> <p>(22) <b>Filing Date :</b> 05.08.2024</p> <p>(24) <b>Registration Date:</b> 18/07/2025</p>	<p>(73) <b>Applicant(s)</b> BEIERSDORF AG, Beiersdorfstrasse 1-9, 22529 Hamburg, Germany</p>	<p>(72) <b>Creators</b> MÄHLMANN Kurt, Germany WIRTH Cristin, Germany CAU Stéfane, Germany</p>						
<p>(30) <b>Priority Data</b></p> <table style="width: 100%; border-collapse: collapse;"> <tr> <td style="width: 33%;">(33) <b>Country</b></td> <td style="width: 33%;">(31) <b>Number</b></td> <td style="width: 33%;">(32) <b>Date</b></td> </tr> <tr> <td>IB</td> <td>DM/238256</td> <td>26.06.2024</td> </tr> </table>	(33) <b>Country</b>	(31) <b>Number</b>	(32) <b>Date</b>	IB	DM/238256	26.06.2024	<p>(74) <b>Representative</b> ADAMS AND ADAMS MOZAMBIQUE, Mozambique</p>	
(33) <b>Country</b>	(31) <b>Number</b>	(32) <b>Date</b>						
IB	DM/238256	26.06.2024						
<p>(84) <b>Designated States:</b> KE TZ UG</p>								
<p>(51) <b>International Classification :</b> 32-01</p>								
<p>(54) <b>Title</b> GRAPHIC DESIGN</p>								



Single Figure

Front view

## Designs Registered (Contd.)

FORM 25	(12) DESIGN	(19) AP/D						
<p><b>(11) Design No :</b> AP/D/01609</p> <p><b>(21) Application No :</b> AP/D/2024/001919</p> <p><b>(22) Filing Date :</b> 05.08.2024</p> <p><b>(24) Registration Date:</b> 18/07/2025</p>	<p><b>(73) Applicant(s)</b> BEIERSDORF AG, Beiersdorfstrasse 1-9, 22529 Hamburg, Germany</p>	<p><b>(72) Creators</b> WIRTH Cristin, Germany MÄHLMANN Kurt, Germany CAU Stéfane, Germany</p>						
<p><b>(30) Priority Data</b></p> <table style="width: 100%; border-collapse: collapse;"> <tr> <td style="width: 33%;"><b>(33) Country</b></td> <td style="width: 33%;"><b>(31) Number</b></td> <td style="width: 33%;"><b>(32) Date</b></td> </tr> <tr> <td>IB</td> <td>DM/238256</td> <td>26.06.2024</td> </tr> </table>	<b>(33) Country</b>	<b>(31) Number</b>	<b>(32) Date</b>	IB	DM/238256	26.06.2024	<p><b>(74) Representative</b> ADAMS AND ADAMS MOZAMBIQUE, Mozambique</p>	
<b>(33) Country</b>	<b>(31) Number</b>	<b>(32) Date</b>						
IB	DM/238256	26.06.2024						
<p><b>(84) Designated States:</b> KE TZ UG</p>								

**(51) International Classification :** 32-01

**(54) Title**  
GRAPHIC DESIGN



Single Figure  
Front view

## Designs Registered (Contd.)

FORM 25	(12) DESIGN	(19) AP/D
(11) Design No : AP/D/01610		<b>(73) Applicant(s)</b> BEIERSDORF AG, Beiersdorfstrasse 1-9, 22529 Hamburg, Germany
(21) Application No : AP/D/2024/001920		
(22) Filing Date : 05.08.2024		
(24) Registration Date: 18/07/2025		
(30) Priority Data		<b>(72) Creators</b> CAU Stéfane, Germany WIRTH Cristin, Germany MÄHLMANN Kurt, Germany
(33) Country (31) Number (32) Date IB DM/238256 26.06.2024		
(84) Designated States: KE TZ UG		<b>(74) Representative</b> ADAMS AND ADAMS MOZAMBIQUE, Mozambique

(51) International Classification : 32-01

(54) Title  
GRAPHIC DESIGN

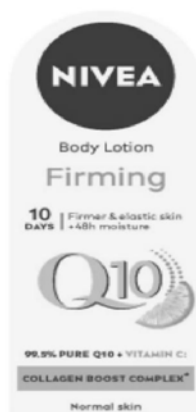

Single Figure

Front view

## Designs Registered (Contd.)

FORM 25	(12) DESIGN	(19) AP/D						
<p>(11) Design No : AP/D/01611</p> <p>(21) Application No : AP/D/2024/001921</p> <p>(22) Filing Date : 05.08.2024</p> <p>(24) Registration Date: 18/07/2025</p>	<p>(73) Applicant(s) BEIERSDORF AG, Beiersdorfstrasse 1-9, 22529 Hamburg, Germany</p>	<p>(72) Creators MÄHLMANN Kurt, Germany WIRTH Cristin, Germany CAU Stéfane, Germany</p>						
<p>(30) Priority Data</p> <table style="width: 100%; border-collapse: collapse;"> <tr> <td style="width: 33%;">(33) Country</td> <td style="width: 33%;">(31) Number</td> <td style="width: 33%;">(32) Date</td> </tr> <tr> <td>IB</td> <td>DM/238256</td> <td>26.06.2024</td> </tr> </table>	(33) Country	(31) Number	(32) Date	IB	DM/238256	26.06.2024	<p>(74) Representative ADAMS AND ADAMS MOZAMBIQUE, Mozambique</p>	
(33) Country	(31) Number	(32) Date						
IB	DM/238256	26.06.2024						
<p>(84) Designated States: KE TZ UG</p>								

(51) International Classification : 32-01

(54) Title  
GRAPHIC DESIGN

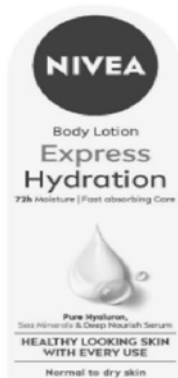

Single Figure  
Front view

## Designs Registered (Contd.)

FORM 25	(12) DESIGN	(19) AP/D						
<p>(11) Design No : AP/D/01612</p> <p>(21) Application No : AP/D/2024/001922</p> <p>(22) Filing Date : 05.08.2024</p> <p>(24) Registration Date: 18/07/2025</p>		<p>(73) Applicant(s) BEIERSDORF AG, Beiersdorfstrasse 1-9, 22529 Hamburg, Germany</p>						
<p>(30) Priority Data</p> <table border="1"> <thead> <tr> <th>(33) Country</th> <th>(31) Number</th> <th>(32) Date</th> </tr> </thead> <tbody> <tr> <td>IB</td> <td>DM/238256</td> <td>26.06.2024</td> </tr> </tbody> </table>	(33) Country	(31) Number	(32) Date	IB	DM/238256	26.06.2024		<p>(72) Creators MÄHLMANN Kurt, Germany WIRTH Cristin, Germany CAU Stéfane, Germany</p>
(33) Country	(31) Number	(32) Date						
IB	DM/238256	26.06.2024						
<p>(84) Designated States: KE TZ UG</p>		<p>(74) Representative ADAMS AND ADAMS MOZAMBIQUE, Mozambique</p>						
<p>(51) International Classification : 32-01</p>								
<p>(54) Title GRAPHIC DESIGN</p>								

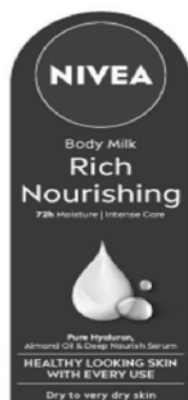

Single Figure  
Front view

## Designs Registered (Contd.)

FORM 25	(12) DESIGN	(19) AP/D						
<p>(11) Design No : AP/D/01613</p> <p>(21) Application No : AP/D/2024/001923</p> <p>(22) Filing Date : 05.08.2024</p> <p>(24) Registration Date: 18/07/2025</p>	<p>(73) Applicant(s) BEIERSDORF AG, Beiersdorfstrasse 1-9, 22529 Hamburg, Germany</p>	<p>(72) Creators WIRTH Cristin, Germany MÄHLMANN Kurt, Germany CAU Stéfane, Germany</p>						
<p>(30) Priority Data</p> <table style="width: 100%; border-collapse: collapse;"> <tr> <td style="width: 33%;">(33) Country</td> <td style="width: 33%;">(31) Number</td> <td style="width: 33%;">(32) Date</td> </tr> <tr> <td>IB</td> <td>DM/238256</td> <td>26.08.2024</td> </tr> </table>	(33) Country	(31) Number	(32) Date	IB	DM/238256	26.08.2024	<p>(74) Representative ADAMS AND ADAMS MOZAMBIQUE, Mozambique</p>	
(33) Country	(31) Number	(32) Date						
IB	DM/238256	26.08.2024						
<p>(84) Designated States: KE TZ UG</p>								

(51) International Classification : 32-01

(54) Title  
GRAPHIC DESIGN

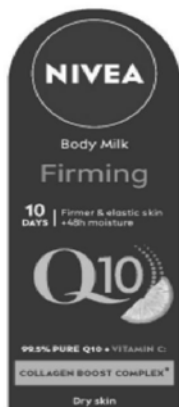

Single Figure  
Front view

## Designs Registered (Contd.)

FORM 25	(12) DESIGN	(19) AP/D						
<p><b>(11) Design No :</b> AP/D/01614</p> <p><b>(21) Application No :</b> AP/D/2024/001959</p> <p><b>(22) Filing Date :</b> 17.10.2024</p> <p><b>(24) Registration Date:</b> 18/07/2025</p>	<p><b>(73) Applicant(s)</b> 180 DEGREES MARKETING (PTY) LTD, Corner Searle and Pontac Streets, Cape Town, Western Cape, 8001, South Africa</p>							
<p><b>(30) Priority Data</b></p> <table style="width: 100%; border-collapse: collapse;"> <tr> <td style="text-align: left;"><b>(33) Country</b></td> <td style="text-align: left;"><b>(31) Number</b></td> <td style="text-align: left;"><b>(32) Date</b></td> </tr> <tr> <td>ZA</td> <td>A2024/00391</td> <td>24.04.2024</td> </tr> </table>	<b>(33) Country</b>	<b>(31) Number</b>	<b>(32) Date</b>	ZA	A2024/00391	24.04.2024	<p><b>(72) Creators</b> MATHIESEN Brian Arthur, South Africa ANDRÉ David Ellis, South Africa</p>	
<b>(33) Country</b>	<b>(31) Number</b>	<b>(32) Date</b>						
ZA	A2024/00391	24.04.2024						
<p><b>(84) Designated States:</b></p> <p style="text-align: center;">BW KE LS NA SZ TZ ZM ZW</p>	<p><b>(74) Representative</b> ROLAND INTELLECTUAL PROPERTY CONSULTANTS, Namibia</p>							
<p><b>(51) International Classification :</b> 14-04</p>								
<p><b>(54) Title</b> SCREEN DISPLAY</p>								



FIG. 1: FRONT VIEW OF A DISPLAY SCREEN OR A PORTION THEREOF WITH A GRAPHICAL USER INTERFACE

## Designs Registered (Contd.)

FORM 25	(12) DESIGN	(19) AP/D						
<p>(11) Design No : AP/D/01615</p> <p>(21) Application No : AP/D/2024/001961</p> <p>(22) Filing Date : 17.10.2024</p> <p>(24) Registration Date: 18/07/2025</p>	<p>(73) Applicant(s) 180 DEGREES MARKETING (PTY) LTD, Corner Searle and Pontac Streets, Cape Town, Western Cape, 8001, South Africa</p>	<p>(72) Creators MATHIESEN Brian Arthur, South Africa ANDRÉ David Ellis, South Africa</p>						
<p>(30) Priority Data</p> <table style="width: 100%; border-collapse: collapse;"> <tr> <td style="width: 33%;">(33) Country</td> <td style="width: 33%;">(31) Number</td> <td style="width: 33%;">(32) Date</td> </tr> <tr> <td>ZA</td> <td>A2024/00393</td> <td>24.04.2024</td> </tr> </table>	(33) Country	(31) Number	(32) Date	ZA	A2024/00393	24.04.2024	<p>(74) Representative ROLAND INTELLECTUAL PROPERTY CONSULTANTS, Namibia</p>	
(33) Country	(31) Number	(32) Date						
ZA	A2024/00393	24.04.2024						
<p>(84) Designated States:</p> <p style="text-align: center;">BW KE LS NA SZ TZ ZM ZW</p>								
<p>(51) International Classification : 14-04</p>								
<p>(54) Title SET OF SCREEN DISPLAYS</p>								



FIG. 9: A FRONT VIEW OF A DISPLAY SCREEN OR A PORTION THEREOF WITH A GRAPHICAL USER INTERFACE SHOWING A NINTH IMAGE

## Designs Registered (Contd.)

FORM 25	(12) DESIGN	(19) AP/D																					
<p>(11) Design No : AP/D/01616</p> <p>(21) Application No : AP/D/2024/001970</p> <p>(22) Filing Date : 06.12.2024</p> <p>(24) Registration Date: 18/07/2025</p>	<p>(73) Applicant(s) ESPRO CAPITAL (PTY) LTD., 231 Chamberlain Road, Mobeni East, Durban 4060, KwaZulu-Natal Province, South Africa</p>	<p>(72) Creators SEEVNARAYAN Prasanth, South Africa</p>																					
<p>(30) Priority Data</p> <table style="width: 100%; border-collapse: collapse;"> <thead> <tr> <th style="text-align: left;">(33) Country</th> <th style="text-align: left;">(31) Number</th> <th style="text-align: left;">(32) Date</th> </tr> </thead> <tbody> <tr> <td>ZA</td> <td>F2024/01108</td> <td>24.10.2024</td> </tr> </tbody> </table>	(33) Country	(31) Number	(32) Date	ZA	F2024/01108	24.10.2024	<p>(74) Representative ADAMS AND ADAMS MOZAMBIQUE, Mozambique</p>																
(33) Country	(31) Number	(32) Date																					
ZA	F2024/01108	24.10.2024																					
<p>(84) Designated States:</p> <table style="width: 100%; border-collapse: collapse;"> <tbody> <tr> <td>BW</td><td>CV</td><td>GH</td><td>GM</td><td>KE</td><td>LR</td><td>LS</td> </tr> <tr> <td>MW</td><td>MZ</td><td>NA</td><td>RW</td><td>SC</td><td>SD</td><td>SL</td> </tr> <tr> <td>ST</td><td>SZ</td><td>TZ</td><td>UG</td><td>ZM</td><td>ZW</td><td></td> </tr> </tbody> </table>	BW	CV	GH	GM	KE	LR	LS	MW	MZ	NA	RW	SC	SD	SL	ST	SZ	TZ	UG	ZM	ZW			
BW	CV	GH	GM	KE	LR	LS																	
MW	MZ	NA	RW	SC	SD	SL																	
ST	SZ	TZ	UG	ZM	ZW																		

(51) International Classification : 06-09

(54) Title  
MATTRESSES

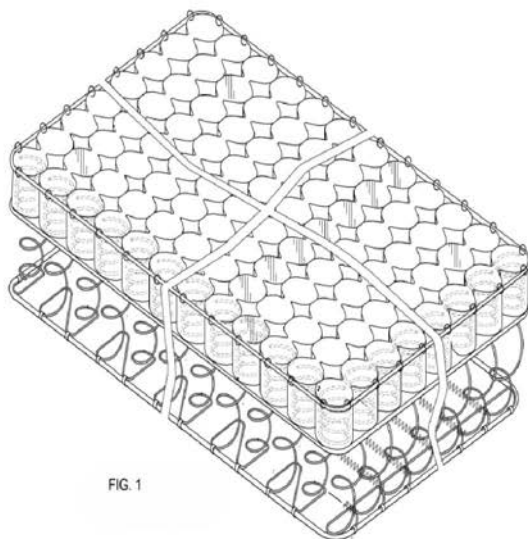

FIG. 1

## Designs Registered (Contd.)

FORM 25	(12) DESIGN	(19) AP/D																					
<p>(11) <b>Design No :</b> AP/D/01617</p> <p>(21) <b>Application No :</b> AP/D/2024/001942</p> <p>(22) <b>Filing Date :</b> 12.09.2024</p> <p>(24) <b>Registration Date:</b> 25/07/2025</p>	<p>(73) <b>Applicant(s)</b> HMD GLOBAL OY, Bertel Jungin Aukio 9, 02600 Espoo, Finland</p> <p>(72) <b>Creators</b> LI Kyle, Peoples Republic of China</p> <p>(74) <b>Representative</b> GALLOWAY &amp; COMPANY, Zimbabwe</p>																						
<p>(30) <b>Priority Data</b></p> <table style="width: 100%; border-collapse: collapse;"> <thead> <tr> <th style="text-align: left;">(33) Country</th> <th style="text-align: left;">(31) Number</th> <th style="text-align: left;">(32) Date</th> </tr> </thead> <tbody> <tr> <td>EM</td> <td>015053442-0001</td> <td>12.03.2024</td> </tr> </tbody> </table>	(33) Country	(31) Number	(32) Date	EM	015053442-0001	12.03.2024																	
(33) Country	(31) Number	(32) Date																					
EM	015053442-0001	12.03.2024																					
<p>(84) <b>Designated States:</b></p> <table style="width: 100%; border-collapse: collapse;"> <tbody> <tr> <td>BW</td> <td>CV</td> <td>GH</td> <td>GM</td> <td>KE</td> <td>LR</td> <td>LS</td> </tr> <tr> <td>MW</td> <td>MZ</td> <td>NA</td> <td>RW</td> <td>SC</td> <td>SD</td> <td>TZ</td> </tr> <tr> <td>UG</td> <td>ZM</td> <td>ZW</td> <td></td> <td></td> <td></td> <td></td> </tr> </tbody> </table>	BW	CV	GH	GM	KE	LR	LS	MW	MZ	NA	RW	SC	SD	TZ	UG	ZM	ZW						
BW	CV	GH	GM	KE	LR	LS																	
MW	MZ	NA	RW	SC	SD	TZ																	
UG	ZM	ZW																					
<p>(51) <b>International Classification :</b> 14-03</p> <p>(54) <b>Title</b> MOBILE PHONE</p>																							



## Designs Registered (Contd.)

FORM 25	(12) DESIGN	(19) AP/D																					
<p>(11) Design No : AP/D/01618</p> <p>(21) Application No : AP/D/2024/001943</p> <p>(22) Filing Date : 12.09.2024</p> <p>(24) Registration Date: 25/07/2025</p>	<p>(73) Applicant(s) HMD GLOBAL OY, Bertel Jungin Aukio 9, 02600 Espoo, Finland</p>	<p>(72) Creators LI Kyle, Peoples Republic of China</p>																					
<p>(30) Priority Data</p> <table style="width: 100%; border-collapse: collapse;"> <tr> <td style="text-align: center;">(33) Country</td> <td style="text-align: center;">(31) Number</td> <td style="text-align: center;">(32) Date</td> </tr> </table>	(33) Country	(31) Number	(32) Date	<p>(74) Representative GALLOWAY &amp; COMPANY, Zimbabwe</p>																			
(33) Country	(31) Number	(32) Date																					
<p>(84) Designated States:</p> <table style="width: 100%; border-collapse: collapse;"> <tr> <td style="text-align: center;">BW</td> <td style="text-align: center;">CV</td> <td style="text-align: center;">GH</td> <td style="text-align: center;">GM</td> <td style="text-align: center;">KE</td> <td style="text-align: center;">LR</td> <td style="text-align: center;">LS</td> </tr> <tr> <td style="text-align: center;">MW</td> <td style="text-align: center;">MZ</td> <td style="text-align: center;">NA</td> <td style="text-align: center;">RW</td> <td style="text-align: center;">SC</td> <td style="text-align: center;">SD</td> <td style="text-align: center;">TZ</td> </tr> <tr> <td style="text-align: center;">UG</td> <td style="text-align: center;">ZM</td> <td style="text-align: center;">ZW</td> <td></td> <td></td> <td></td> <td></td> </tr> </table>	BW	CV	GH	GM	KE	LR	LS	MW	MZ	NA	RW	SC	SD	TZ	UG	ZM	ZW						
BW	CV	GH	GM	KE	LR	LS																	
MW	MZ	NA	RW	SC	SD	TZ																	
UG	ZM	ZW																					
<p>(51) International Classification : 14-03</p>																							
<p>(54) Title MOBILE PHONE</p>																							

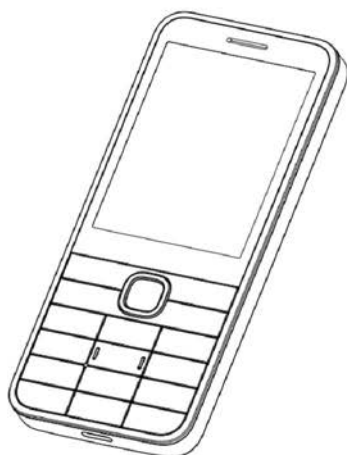

## Designs Registered (Contd.)

FORM 25	(12) DESIGN	(19) AP/D																					
<p><b>(11) Design No :</b> AP/D/01619</p> <p><b>(21) Application No :</b> AP/D/2024/001951</p> <p><b>(22) Filing Date :</b> 27.09.2024</p> <p><b>(24) Registration Date:</b> 25/07/2025</p>	<p><b>(73) Applicant(s)</b> HMD GLOBAL OY, Bertel Jungin Aukio 9, 02600 Espoo, Finland</p>	<p><b>(72) Creators</b> MAHONEN Miika, Finland</p>																					
<p><b>(30) Priority Data</b></p> <table style="width: 100%; border-collapse: collapse;"> <tr> <th style="text-align: left;">(33) Country</th> <th style="text-align: left;">(31) Number</th> <th style="text-align: left;">(32) Date</th> </tr> <tr> <td>EM</td> <td>015055255-0001</td> <td>28.03.2024</td> </tr> </table>	(33) Country	(31) Number	(32) Date	EM	015055255-0001	28.03.2024	<p><b>(74) Representative</b> GALLOWAY &amp; COMPANY, Zimbabwe</p>																
(33) Country	(31) Number	(32) Date																					
EM	015055255-0001	28.03.2024																					
<p><b>(84) Designated States:</b></p> <table style="width: 100%; border-collapse: collapse;"> <tr> <td>BW</td><td>CV</td><td>GH</td><td>GM</td><td>KE</td><td>LR</td><td>LS</td> </tr> <tr> <td>MW</td><td>MZ</td><td>NA</td><td>RW</td><td>SC</td><td>SD</td><td>TZ</td> </tr> <tr> <td>UG</td><td>ZM</td><td>ZW</td><td></td><td></td><td></td><td></td> </tr> </table>	BW	CV	GH	GM	KE	LR	LS	MW	MZ	NA	RW	SC	SD	TZ	UG	ZM	ZW						
BW	CV	GH	GM	KE	LR	LS																	
MW	MZ	NA	RW	SC	SD	TZ																	
UG	ZM	ZW																					
<p><b>(51) International Classification :</b> 14-03</p>																							
<p><b>(54) Title</b> MOBILE PHONE</p>																							



1.1

## Designs Registered (Contd.)

FORM 25	(12) DESIGN	(19) AP/D																											
<p>(11) <b>Design No :</b> AP/D/01620</p> <p>(21) <b>Application No :</b> AP/D/2024/001966</p> <p>(22) <b>Filing Date :</b> 19.11.2024</p> <p>(24) <b>Registration Date:</b> 25/07/2025</p>	<p><b>(73) Applicant(s)</b> HILLTOP MANUFACTURING AND TRADING COMPANY LIMITED, Plot 1&amp;2, Kigoma Hilltop Hotel Bangwe Road, Kigoma Tanzania</p>	<p><b>(72) Creators</b> MOHSIN Abdullah Lalji, Tanzania</p>																											
<p>(30) <b>Priority Data</b></p> <table style="width: 100%; border-collapse: collapse;"> <thead> <tr> <th style="text-align: left;">(33) Country</th> <th style="text-align: left;">(31) Number</th> <th style="text-align: left;">(32) Date</th> </tr> </thead> <tbody> <tr> <td> </td> <td> </td> <td> </td> </tr> </tbody> </table>	(33) Country	(31) Number	(32) Date				<p><b>(74) Representative</b> HILLTOP MANUFACTURING AND TRADING COMPANY LIMITED, Tanzania</p>	<p>(84) <b>Designated States:</b></p> <table style="width: 100%; border-collapse: collapse;"> <tbody> <tr> <td>BW</td><td>CV</td><td>GH</td><td>GM</td><td>KE</td><td>LR</td><td>LS</td> </tr> <tr> <td>MW</td><td>MZ</td><td>NA</td><td>RW</td><td>SC</td><td>SD</td><td>SL</td> </tr> <tr> <td>ST</td><td>SZ</td><td>TZ</td><td>UG</td><td>ZM</td><td>ZW</td><td> </td> </tr> </tbody> </table>	BW	CV	GH	GM	KE	LR	LS	MW	MZ	NA	RW	SC	SD	SL	ST	SZ	TZ	UG	ZM	ZW	
(33) Country	(31) Number	(32) Date																											
BW	CV	GH	GM	KE	LR	LS																							
MW	MZ	NA	RW	SC	SD	SL																							
ST	SZ	TZ	UG	ZM	ZW																								
<p>(51) <b>International Classification :</b> 09-01</p>																													
<p>(54) <b>Title</b> CRYSTAL SPRINGS</p>																													



## Designs Registered (Contd.)

FORM 25	(12) DESIGN	(19) AP/D						
<p>(11) Design No : AP/D/01621</p> <p>(21) Application No : AP/D/2024/001973</p> <p>(22) Filing Date : 19.12.2024</p> <p>(24) Registration Date: 25/07/2025</p>	<p>(73) Applicant(s) BAJAJ AUTO LIMITED, Mumbai-Pune Road, Akurdi, Pune, 411035, India</p>	<p>(72) Creators ARUNKUMAR Francis, India FABBRO Gianandrea, India ADHIKARI Rahul P, India</p>						
<p>(30) Priority Data</p> <table style="width: 100%; border-collapse: collapse;"> <tr> <td style="width: 33%;">(33) Country</td> <td style="width: 33%;">(31) Number</td> <td style="width: 33%;">(32) Date</td> </tr> <tr> <td>IN</td> <td>421825-001</td> <td>01.07.2024</td> </tr> </table>	(33) Country	(31) Number	(32) Date	IN	421825-001	01.07.2024	<p>(74) Representative SPOOR.FISHER, Ghana</p>	
(33) Country	(31) Number	(32) Date						
IN	421825-001	01.07.2024						
<p>(84) Designated States: TZ</p>								

(51) International Classification : 12-11

(54) Title  
MOTORCYCLE



Fig. 2 RIGHT FRONT PERSPECTIVE VIEW



## Designs Registered (Contd.)

FORM 25	(12) DESIGN	(19) AP/D						
<p>(11) Design No : AP/D/01623</p> <p>(21) Application No : AP/D/2024/001975</p> <p>(22) Filing Date : 27.12.2024</p> <p>(24) Registration Date: 29/07/2025</p>	<p>(73) Applicant(s) TORRENT INNOVA, S.L., Lugar el Martillo, s/n E-11500 El Puerto de Santa María, Cádiz, Spain</p>	<p>(72) Creators JIMÉNEZ GÁLVEZ Eduardo, Spain GUERRERO GAMAZA Jorge Antonio, Spain YARUSSI Carlos, Spain</p>						
<p>(30) Priority Data</p> <table style="width: 100%; border-collapse: collapse;"> <tr> <td style="width: 33%;">(33) Country</td> <td style="width: 33%;">(31) Number</td> <td style="width: 33%;">(32) Date</td> </tr> <tr> <td>EU</td> <td>015065066</td> <td>28.06.2024</td> </tr> </table>	(33) Country	(31) Number	(32) Date	EU	015065066	28.06.2024	<p>(74) Representative SPOOR.FISHER, Ghana</p>	
(33) Country	(31) Number	(32) Date						
EU	015065066	28.06.2024						
<p>(84) Designated States: KE UG</p>								

(51) International Classification : 09-07

(54) Title  
CLOSURE FOR A BOTTLE

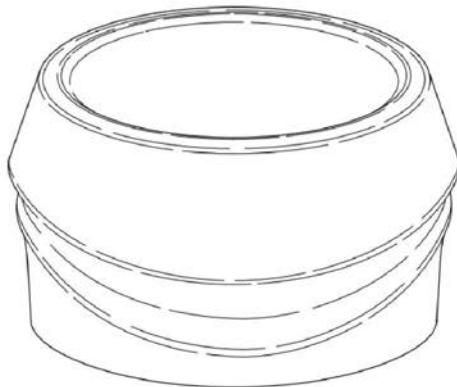

FIG. 10

## Designs Registered (Contd.)

FORM 25	(12) DESIGN	(19) AP/D						
<p>(11) Design No : AP/D/01624</p> <p>(21) Application No : AP/D/2024/001930</p> <p>(22) Filing Date : 23.08.2024</p> <p>(24) Registration Date: 30/07/2025</p>	<p>(73) Applicant(s) BEIERSDORF AG, Beiersdorfstrasse 1-9, 22529 Hamburg, Germany</p>	<p>(72) Creators CAU Stéfane, Germany MÄHLMANN Kurt, Germany WIRTH Cristin, Germany</p>						
<p>(30) Priority Data</p> <table style="width: 100%; border-collapse: collapse;"> <thead> <tr> <th style="text-align: left;">(33) Country</th> <th style="text-align: left;">(31) Number</th> <th style="text-align: left;">(32) Date</th> </tr> </thead> <tbody> <tr> <td>IB</td> <td>DM/237394</td> <td>16.05.2024</td> </tr> </tbody> </table>	(33) Country	(31) Number	(32) Date	IB	DM/237394	16.05.2024	<p>(74) Representative ADAMS AND ADAMS MOZAMBIQUE, Mozambique</p>	
(33) Country	(31) Number	(32) Date						
IB	DM/237394	16.05.2024						
<p>(84) Designated States: KE TZ UG</p>								

(51) International Classification : 09-01

(54) Title  
COSMETIC BOTTLE



Figure 1  
Three-dimensional view

## Designs Registered (Contd.)

FORM 25	(12) DESIGN	(19) AP/D						
<p>(11) <b>Design No :</b> AP/D/01625</p> <p>(21) <b>Application No :</b> AP/D/2024/001931</p> <p>(22) <b>Filing Date :</b> 23.08.2024</p> <p>(24) <b>Registration Date:</b> 30/07/2025</p>	<p>(73) <b>Applicant(s)</b> BEIERSDORF AG, Beiersdorfstrasse 1-9, 22529 Hamburg, Germany</p>	<p>(72) <b>Creators</b> WIRTH Cristin, Germany MÄHLMANN Kurt, Germany CAU Stéfane, Germany</p>						
<p>(30) <b>Priority Data</b></p> <table style="width: 100%; border-collapse: collapse;"> <tr> <td style="width: 33%;"><b>(33) Country</b></td> <td style="width: 33%;"><b>(31) Number</b></td> <td style="width: 33%;"><b>(32) Date</b></td> </tr> <tr> <td>IB</td> <td>DM/237394</td> <td>16.05.2024</td> </tr> </table>	<b>(33) Country</b>	<b>(31) Number</b>	<b>(32) Date</b>	IB	DM/237394	16.05.2024	<p>(74) <b>Representative</b> ADAMS AND ADAMS MOZAMBIQUE, Mozambique</p>	
<b>(33) Country</b>	<b>(31) Number</b>	<b>(32) Date</b>						
IB	DM/237394	16.05.2024						
<p>(84) <b>Designated States:</b> KE TZ UG</p>								

(51) **International Classification :** 09-01

(54) **Title**  
COSMETIC BOTTLE



Figure 1  
Three-dimensional view

## Designs Registered (Contd.)

FORM 25	(12) DESIGN	(19) AP/D						
<p><b>(11) Design No :</b> AP/D/01626</p> <p><b>(21) Application No :</b> AP/D/2024/001932</p> <p><b>(22) Filing Date :</b> 23.08.2024</p> <p><b>(24) Registration Date:</b> 30/07/2025</p>	<p><b>(73) Applicant(s)</b> BEIERSDORF AG, Beiersdorfstrasse 1-9, 22529 Hamburg, Germany</p>	<p><b>(72) Creators</b> MÄHLMANN Kurt, Germany WIRTH Cristin, Germany CAU Stéfane, Germany</p>						
<p><b>(30) Priority Data</b></p> <table style="width: 100%; border-collapse: collapse;"> <tr> <td style="width: 33%;"><b>(33) Country</b></td> <td style="width: 33%;"><b>(31) Number</b></td> <td style="width: 33%;"><b>(32) Date</b></td> </tr> <tr> <td>IB</td> <td>DM/237394</td> <td>16.05.2024</td> </tr> </table>	<b>(33) Country</b>	<b>(31) Number</b>	<b>(32) Date</b>	IB	DM/237394	16.05.2024	<p><b>(74) Representative</b> ADAMS AND ADAMS MOZAMBIQUE, Mozambique</p>	
<b>(33) Country</b>	<b>(31) Number</b>	<b>(32) Date</b>						
IB	DM/237394	16.05.2024						
<p><b>(84) Designated States:</b> KE TZ UG</p>								

**(51) International Classification :** 09-01

**(54) Title**  
COSMETIC BOTTLE



Figure 1  
Three-dimensional view

## Designs Renewed

Design No.	Application No.	Date Fee Paid	Valid Until	Anniversary
AP/D/00901	AP/D/2016/001135	21.07.2025	10.08.2026	9th yr
AP/D/00964	AP/D/2017/001196	27.06.2025	28.06.2026	8th yr
AP/D/00966	AP/D/2017/001197	27.06.2025	28.06.2026	8th yr
AP/D/00971	AP/D/2017/001209	28.07.2025	10.08.2026	8th yr
AP/D/00986	AP/D/2017/001207	28.07.2025	04.08.2026	8th yr
AP/D/00993	AP/D/2017/001199	03.07.2025	12.07.2026	8th yr
AP/D/00994	AP/D/2017/001204	18.07.2025	21.07.2026	8th yr
AP/D/01021	AP/D/2018/001277	30.07.2025	24.05.2026	7th yr
AP/D/01035	AP/D/2018/001292	28.07.2025	30.07.2026	7th yr
AP/D/01071	AP/D/2018/001324	27.06.2025	25.09.2026	7th yr
AP/D/01141	AP/D/2019/001411	18.07.2025	30.08.2026	6th yr
AP/D/01163	AP/D/2019/001409	02.07.2025	29.08.2026	6th yr
AP/D/01171	AP/D/2020/001491	08.07.2025	24.07.2026	5th yr
AP/D/01172	AP/D/2020/001490	08.07.2025	24.07.2026	5th yr
AP/D/01173	AP/D/2020/001489	08.07.2025	24.07.2026	5th yr
AP/D/01174	AP/D/2020/001488	08.07.2025	24.07.2026	5th yr
AP/D/01180	AP/D/2020/001478	08.07.2025	10.07.2026	5th yr
AP/D/01181	AP/D/2020/001477	08.07.2025	10.07.2026	5th yr
AP/D/01183	AP/D/2020/001492	02.07.2025	21.08.2026	5th yr
AP/D/01184	AP/D/2020/001493	02.07.2025	21.08.2026	5th yr
AP/D/01189	AP/D/2020/001499	08.07.2025	17.09.2026	5th yr
AP/D/01196	AP/D/2020/001498	08.07.2025	30.07.2026	5th yr
AP/D/01226	AP/D/2020/001482	21.07.2025	20.07.2026	5th yr
AP/D/01257	AP/D/2021/001555	23.06.2025	23.06.2026	4th yr
AP/D/01260	AP/D/2021/001578	22.07.2025	10.09.2026	4th yr
AP/D/01265	AP/D/2021/001579	23.07.2025	10.09.2026	4th yr
AP/D/01266	AP/D/2021/001575	08.07.2025	06.09.2026	4th yr
AP/D/01275	AP/D/2021/001576	22.07.2025	06.09.2026	4th yr
AP/D/01325	AP/D/2022/001640	31.07.2025	22.02.2026	3rd yr
AP/D/01352	AP/D/2022/001679	22.07.2025	24.05.2025	2nd yr
AP/D/01352	AP/D/2022/001679	22.07.2025	24.05.2026	3rd yr
AP/D/01369	AP/D/2022/001697	18.07.2025	03.08.2026	3rd yr
AP/D/01377	AP/D/2022/001700	08.07.2025	17.08.2026	3rd yr
AP/D/01379	AP/D/2022/001699	23.06.2025	11.08.2026	3rd yr
AP/D/01382	AP/D/2022/001701	08.07.2025	17.08.2026	3rd yr
AP/D/01394	AP/D/2022/001711	28.07.2025	23.09.2026	3rd yr
AP/D/01399	AP/D/2022/001712	21.07.2025	08.08.2026	3rd yr
AP/D/01451	AP/D/2023/001790	10.07.2025	17.07.2026	2nd yr

## Designs Renewed (Contd.)

Design No.	Application No.	Date Fee Paid	Valid Until	Anniversary
AP/D/01452	AP/D/2023/001792	10.07.2025	17.07.2026	2nd yr
AP/D/01453	AP/D/2023/001791	10.07.2025	17.07.2026	2nd yr
AP/D/01454	AP/D/2023/001794	23.06.2025	26.07.2026	2nd yr
AP/D/01455	AP/D/2023/001800	14.07.2025	07.08.2026	2nd yr
AP/D/01457	AP/D/2023/001798	15.07.2025	28.07.2026	2nd yr
AP/D/01466	AP/D/2023/001802	28.07.2025	08.08.2026	2nd yr
AP/D/01475	AP/D/2023/001780	02.07.2025	19.06.2026	2nd yr
AP/D/01476	AP/D/2023/001781	02.07.2025	19.06.2026	2nd yr
AP/D/01477	AP/D/2023/001782	02.07.2025	19.06.2026	2nd yr
AP/D/01478	AP/D/2023/001783	02.07.2025	19.06.2026	2nd yr
AP/D/01479	AP/D/2023/001784	02.07.2025	19.06.2026	2nd yr
AP/D/01480	AP/D/2023/001785	02.07.2025	19.06.2026	2nd yr
AP/D/01483	AP/D/2023/001786	02.07.2025	19.06.2026	2nd yr
AP/D/01484	AP/D/2023/001787	02.07.2025	19.06.2026	2nd yr
AP/D/01485	AP/D/2023/001789	10.07.2025	17.07.2026	2nd yr
AP/D/01539	AP/D/2023/001774	22.07.2025	28.04.2026	2nd yr
AP/D/01553	AP/D/2024/001910	23.06.2025	22.07.2026	1st yr
AP/D/01565	AP/D/2024/001908	16.07.2025	19.07.2026	1st yr
AP/D/01566	AP/D/2024/001909	16.07.2025	19.07.2026	1st yr
AP/D/01567	AP/D/2024/001924	16.07.2025	07.08.2026	1st yr
AP/D/01568	AP/D/2024/001911	23.06.2025	25.07.2026	1st yr
AP/D/01570	AP/D/2024/001934	16.07.2025	27.08.2026	1st yr
AP/D/01578	AP/D/2024/001907	09.07.2025	15.07.2026	1st yr
AP/D/01584	AP/D/2024/001905	27.06.2025	26.06.2026	1st yr
AP/D/01590	AP/D/2024/001906	27.06.2025	02.07.2026	1st yr
AP/D/01604	AP/D/2024/001914	28.07.2025	05.08.2026	1st yr
AP/D/01605	AP/D/2024/001915	28.07.2025	05.08.2026	1st yr
AP/D/01606	AP/D/2024/001916	28.07.2025	05.08.2026	1st yr
AP/D/01607	AP/D/2024/001917	28.07.2025	05.08.2026	1st yr
AP/D/01608	AP/D/2024/001918	28.07.2025	05.08.2026	1st yr
AP/D/01609	AP/D/2024/001919	28.07.2025	05.08.2026	1st yr
AP/D/01610	AP/D/2024/001920	28.07.2025	05.08.2026	1st yr
AP/D/01611	AP/D/2024/001921	28.07.2025	05.08.2026	1st yr
AP/D/01612	AP/D/2024/001922	28.07.2025	05.08.2026	1st yr
AP/D/01613	AP/D/2024/001923	28.07.2025	05.08.2026	1st yr

## SEARCH REQUESTS FILED

Search No.	Request Date	Originating State	Type	Requester's Name	Subject
SR07106/BW	03/10/2024	BW	Substantive Examination	Companies and Intellectual Property Authority	Digital Energy Management System for Real-Time Household Power Monitoring and Optimization in the name of University of Botswana
SR07315/UG	25/03/2025	UG	Substantive Examination	UGANDA REGISTRATION SERVICES BUREAU	Institutional Sludge Dewa tering and Recovery system in the name of SEMAKULA Allan Tadeo
SR07360/UG	12/05/2025	UG	Substantive Examination	UGANDA REGISTRATION SERVICES BUREAU	Electric drive valve, flowmeter and water supply device using thereof in the name of KOJIMA Hisashi
SR07388/GH	09/06/2025	GH	Substantive Examination	REGISTRAR-GENERAL DEPARTMENT - GHANA	CONTROL DEVICE FOR MASSAGER AND METHOD THEREFOR
SR07389/GH	09/06/2025	GH	Substantive Examination	REGISTRAR-GENERAL DEPARTMENT - GHANA	Low Altitude Maglev Axial-hybrid Wind Turbine (Lam-ahwt)
SR07390/GH	09/06/2025	GH	Substantive Examination	REGISTRAR-GENERAL DEPARTMENT - GHANA	Noghusam Cocoa Breaking Machine
SR07391/GH	09/06/2025	GH	Substantive Examination	REGISTRAR-GENERAL DEPARTMENT - GHANA	Semi-automatic Pepper Seedling Transplanter
SR07392/GH	09/06/2025	GH	Substantive Examination	REGISTRAR-GENERAL DEPARTMENT - GHANA	Turbocharger Gas Turbine Engine
SR07393/GH	09/06/2025	GH	Substantive Examination	REGISTRAR-GENERAL DEPARTMENT - GHANA	Turbocharger Jet Engine Heat System
SR07399/ZW	11/06/2025	ZW		RAINBOW PHARMACEUTICALS	Trademark search for 'IVYCOF'
SR07412/ZW	19/06/2025	ZW		WINTERTONS LEGAL PRACTITIONERS	Trademark search in the name of Creamly, Creamola, La Crème, Rich Mix, Crème Gold and Kreamella.
SR07416/GH	24/06/2025	GH		SPOOR.FISHER	Equivalent Search
SR07423/ZW	27/06/2025	ZW	SDI	WINTERTONS LEGAL PRACTITIONERS	Trademark status search for MAMA'S AND FARMGOLD.
SR07424/UG	30/06/2025	UG		MPANGA Jeremy	Inquiry about registration of trademarks outside of Uganda.
SR07425/CN	10/06/2025	CN	SDI	ZHEJIANG POLARIS LAW FIRM	Inquiry about trademark registraon in ARIPO
SR07426/TZ	30/06/2025	TZ	SDI	CHAMANI Azizi	Inquiry Regarding Regional IP Protection for CargoLink
SR07427/TZ	30/06/2025	TZ		MWAKIBIKI MGWILA EDGAR	Mark availability search for YOGURLAND in class 30 and 43.
SR07428/ZW	01/07/2025	ZW	SDI	RUZIWA Tatenda	Information regarding IP filing
SR07430/ZW	04/07/2025	ZW	SDI	TSIGA Lisa	Request for Utility Model Document for Sugarcane Bites
SR07435/GH	08/07/2025	GH		SPOOR.FISHER	Equivalent Search for PCT/EP2006/050328 (WO 2006077242) and e EU Community Design No. EU 000354477-0001 or US Design No US D551,759.
SR07437/ZW	08/07/2025	ZW		AT MUZA ATTORNEYS	Mark availability search for BARAZA in class 35
SR07439/BW	10/07/2025	BW		AT MUZA ATTORNEYS	Trademark search for 'The Dairy Den'.
SR07440/ZW	10/07/2025	ZW		TANYANYIWA AND ASSOCIATES	Request to be listed as IP Agent
SR07441/ZW	14/07/2025	ZW	SDI	TYOKA Gladstone	Information on trademarks and patents registration

## SEARCH REQUESTS FILED (Contd.)

Search No.	Request Date	Originating State	Type	Requester's Name	Subject
SR07442/IT	14/07/2025	IT	SDI	Mariniello Lucia	Information on trademark registration
SR07443/ZW	15/07/2025	ZW		Ndlovu Sarah Abigail	Information regarding change of name
SR07447/TZ	16/07/2025	TZ	SDI	MAKENYA Irene Amanda	Information on trademark registration
SR07448/TZ	17/07/2025	TZ	Information about ARIPO	ALOYCE Cyprian	Information on how to be an ARIPO Agent
SR07449/ZW	21/07/2025	ZW	SDI	Makore Abgiri Tendai	Information regarding Trademark Registration and Utility Model
SR07450/ZW	21/07/2025	ZW		MUTUDA Tiana	Mark availability Search
SR07454/KE	24/07/2025	KE		Muriu Mungai & Co. Advocates LLP t/a MMC Asafo	Inquiry on Trademarks status search in Aripo Database



Printed and published by ARIPO.  
P.O. Box 4228, Harare, Zimbabwe.  
Tel (+263 4) 794065/6/8/74.  
E-mail - [mail@aripo.org](mailto:mail@aripo.org).  
Website - [www.aripo.org](http://www.aripo.org).